

X100DR®

XCA Series Production Cable Adaptor Wiring Diagrams



INTERFACE TROUBLESHOOTING



First read X10DR installation Instruction Guide

Most problems getting the X10DR to work with your radio usually come down to simple things easily overlooked. These include: -

1/ Failing to use the XGALA audio level tool (download at x10dr.com) to program the X10DR Mic audio level output from the gateway so that it **matches the radio's fist mic level**.

2/ Failing to program the Gateway so that X10DR speaker level is loud but not distorted.

3/ Forgetting to program or jumper your radio's interface connector to provide the REQUIRED function input/output on the specified pins. These include: enabling Emergency input with active low, enabling COR with active low output, Setting radio Rx audio to be muted when radio is squelched, setting external mic input for analog audio, etc. A number of Kenwood radios need a resistor/s moved to allow external mic input on their accessory connector.

If you build your own interface cables:

1/ Not connecting the right wire to the right pin.

2/ Some radios such as Kenwood models have a 5 mV input sensitivity (non-electret Mics) . If you build your own interface cables, you should fit a 8-10K resistor in series with the radio's external mic input to reduce the audio level sent from the X10DR otherwise noise will exist and audio will distort badly. You will also need to connect a 100K resistor from SwB+ (see below)

3/ Failing to use shielded CAT5 cables.

Other Issues

NO COR available:

Leave pin 6 of X10DR input isolated and let X10DR internal VOX create an internal COR function. There will usually be minimal lost Rx audio, but if so maybe a syllable lost from Rx audio after no traffic for a while.

No Auto On/Off function:

Make sure the radio/device's Mic Hi input has a DC voltage on it when powered ON

If not, fit a 100K resistor between X10DR Pin 4 and the host mobile radios switched B+ output.

Noisy Audio

95% of the time this is due to poor earthing of the radio or the X10DR gateway antenna, You can try soldering a ground strap on the RJ45 exposed shield that plugs into the Gateway base and ground this to nearby vehicle chassis. (refer to X10DR Installation Instruction Guide for more information- download at: www.x10dr.com)

XCA Cable Adaptors



NOTE: for reference only*

Not all models available - Refer Pricebook

XCA Type 2 adaptors can be opened and modified if required

XCA-M26	Suits Motorola 26 pin Mototrbo	
XCA-M26T	Suits Motorola 26 pin MTM5400	
XCA-M16	Suits Motorola 16 pin	
XCA-M16T	Suits Motorola 16 pin TETRA MTM800	
XCA-APX	Suits Motorola APX/XTL	
XCA-VM9	Suits Kenwood/EFJ VM900 DB25	
XCA-K25	Suits Kenw.DB25: NX700/TK5710/TK7180 etc	
XCA-K25N	Suits Kenw. DB25 NX700/TK5710/7180	Type 2
XCA-K25A	Suits Kenwood DB25 TK690/790 etc	
XCA-K25M	Suits Kenwood DB25 TK690/790 etc	Type 2
XCA-K15D	Suits Kenwood DB15HD for NX720	
XCA-K15S	Suits Kenwood DB15HD for TK8360/7360	
XCA-RJK	Suits Kenwood simple low end radios	Type 3
XCA-I25A	Suits Icom DB25	
XCA-I15M	Suits Icom DB15HD	Type 2
XCA-RJi	Suits Kenwood simple low end radios	Type 3
XCA-G25M	Suits GME DB25	Type 2
XCA-SD6	Suits Simoco SDM600	
XCA-SD7	Suits Simoco SDM700	
XCA-SRG	Suits Sepura SRG3900	
XCA-SRM	Suits Simoco SRM9000	
XCA-V15M	Suits Vertex DB15HD	Type 2
XCA-V25	Suits Vertex DB25	
XCA-T15	Suits Tait DB15 (Non DMR)	
XCA-T15D	Suits Tait TM9300 DMR radio	
XCA-T15A	Suits Tait DB15 (Non DMR) Emerg Pin1	
XCA-H26	Suits Hytera MD68/78X	
XCA-R25	Suits RELM/BK DB25	
XCA-R15M	Suits RELM/BK G/DMH DB15HD	Type 2
XCA-T26M	Suits Teltronic DB26	Type 2
XCA-C26M	Suits Airbus TMR DB26	Type 2
XCA-HXGM	Suits Harris XGT/M7300	Type 2
XCA-H37	Suits Harris M7100	
XCA-X44	Suits Harris XL-185/200 (DB44)	
XCA-X25	Suits Harris XL-185/200 (DB25)	
XCA-EXP	Suits Cobham Satellite	
XCA-XMC	Converts XMC cables for 2nd Gen X10DR	
XMC-RJ45	Converts XIC cables for 1st Gen X10DR	
XCA-RJ	PTT & Emergency buffered output adaptor	
XCA-GEN	Generic RJ45-F adaptor for self assembly	
XCA-U15M	Generic partially term DB15 male	Type 2
XCA-U25M	Generic partially term DB25 male	Type 2
XCA-CUS	New model- Custom configuration*	
	*MOQ 200 - Call for pricing-delivery	
XIC series	Interface cables	
XEC-4.5	Extension cables	

**Interface diagrams are believed to be correct at time of publication or revision. If in doubt please check radio manufacturer's service manuals to confirm your requirement.*

Please advise if you find errors and they will be quickly rectified.

XCA-M26 Cable Adaptor: for Motorola Trbo XPR and DM3600 etc series



Female RJ45 shielded

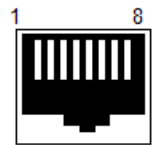
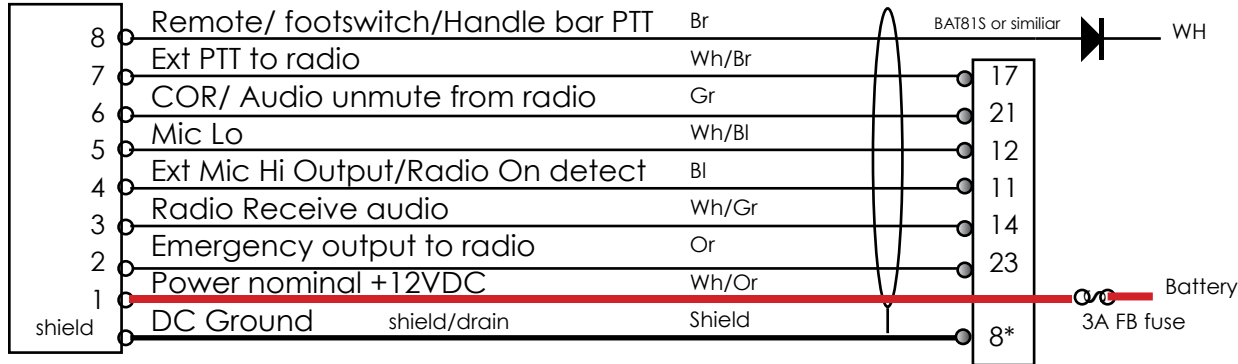

Front View
Receptacle

Motorola Trbo 26 Pin

*earlier cables pin 16

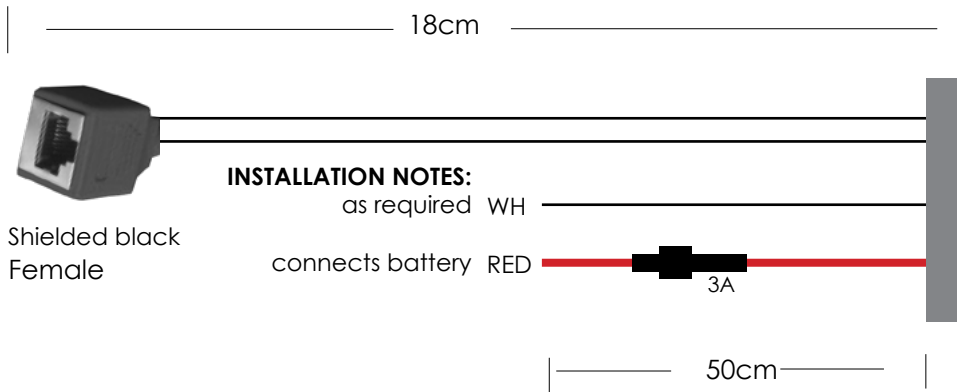

INSTALLATION NOTES:

as required WH

connects battery RED

Shielded black Female

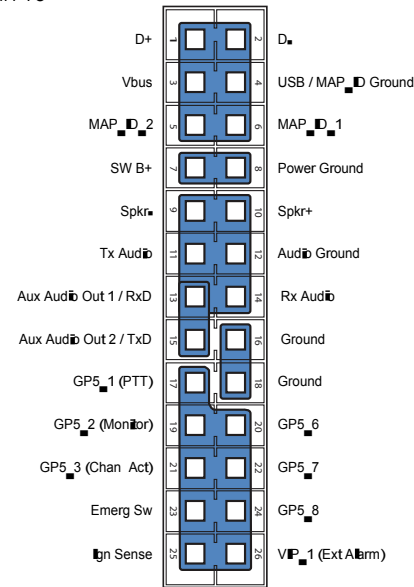

Rear View



Copyright WCL 2020

Date: Aug 12th 2019 Revision:2

Conventional & Connect Series

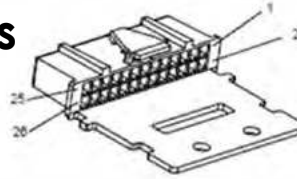

PMLN5072A Accessory connector kit containing:
Seal, Part No 3202606Y02
Crimp Contact, Part No 2984249N01

View from rear

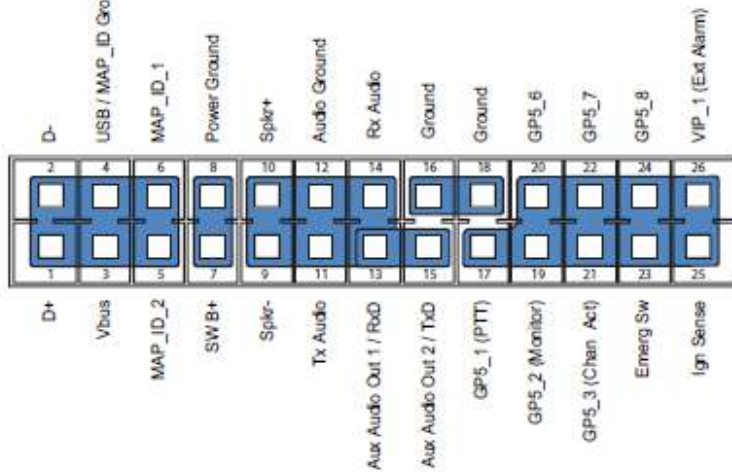

Table 4-1 Rear Accessory Connector Pin Functions

Pin No.	Pin Name	Pin Function	Pin No.	Pin Name	Pin Function
1	USB+	USB + (Data)	14	Rx Audio	Receive Live Audio ⁴
2	USB-	USB - (Data)	15	AUX Audio 2	PUBLIC Address 2
3	VBUS	USB Power (5V from USB accessory/cable)	16	GND	Ground
4	USB/MAP_ID GND	USB/MAP_ID Ground	17	GP5-1 (PTT)	5V Level GPIO, PTT Input ¹
5	MAP_ID_2	Accessory Identifier	18	GND	Ground
6	MAP_ID_1	Accessory Identifier	19	GP5-2 (Monitor)	5V Level GPIO, Monitor Input ³
7	SW B+	Switched Battery Voltage	20	GP5-8	5V Level GPIO
8	PWRGND	Ground	21	GP5-3	5V Level GPIO, Channel Activity Function
9	SPKR-	Speaker - (3.2 ohm minimum impedance)	22	GP5-7	5V Level GPIO
10	SPKR+	Speaker + (3.2 ohm minimum impedance)	23	EMERGENCY	Emergency Switch Input
11	Tx Audio	Rear External Microphone Input ⁴	24	GP5-7	5V Level GPIO
12	Audio GND	Audio Ground	25	IGN SENSE	Ignition Sense ⁵
13	AUX Audio 1	PUBLIC Address 1	26	VIP-1	12V Tolerant, 5V GPIO, External Alarm

Accessory Connection Plan

CAUTION

The accessory connections shown are not compatible to some other models of Motorola radios. Check the appropriate accessory or technical manual for further information. Ensure correct position of the accessory connector.

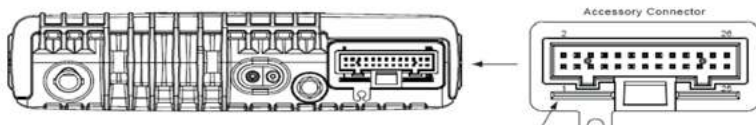

- ¹ Pulling this line to ground will activate PTT function, activating the AUX_MIC input.
- ² Fixed level (independent of volume level) received audio signal, including alert tones. Flat or de-emphasis are programmed by CPS. Output voltage is approximately 330 mVrms per 1kHz of deviation.
- ³ This input is used to detect when a rear microphone accessory is taken off-hook, to override PL to alert the user to busy traffic prior to transmitting.
- ⁴ This microphone signal is independent of the microphone signal on the front microphone connector. The nominal input level is 80mVrms for 60% deviation. The DC impedance is 660 ohms and the AC impedance is 560 ohms.

XMC-M26 Mototrbo Set-up P 2/4

Conventional & Connect Series

Make sure you are in "EXPERT" mode for the CPS.

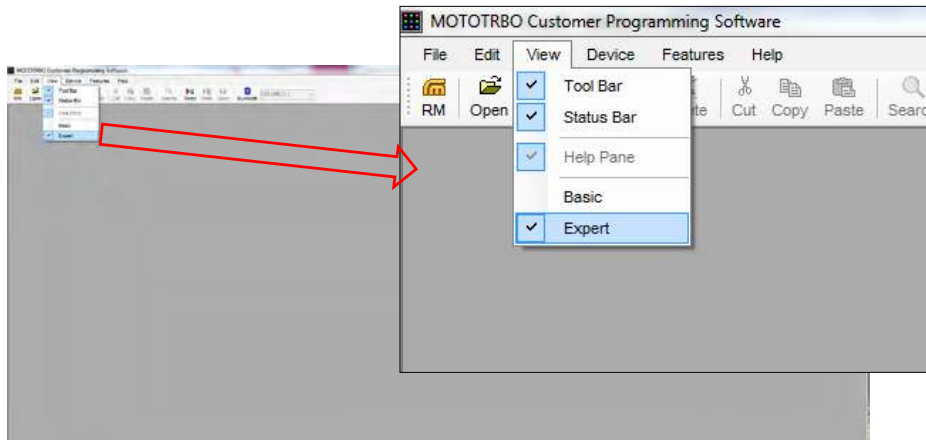

Now go to General Settings:
-Set Vox Sensitivity to : Level 2
-Set Hot Mic Source to: Rear Connector

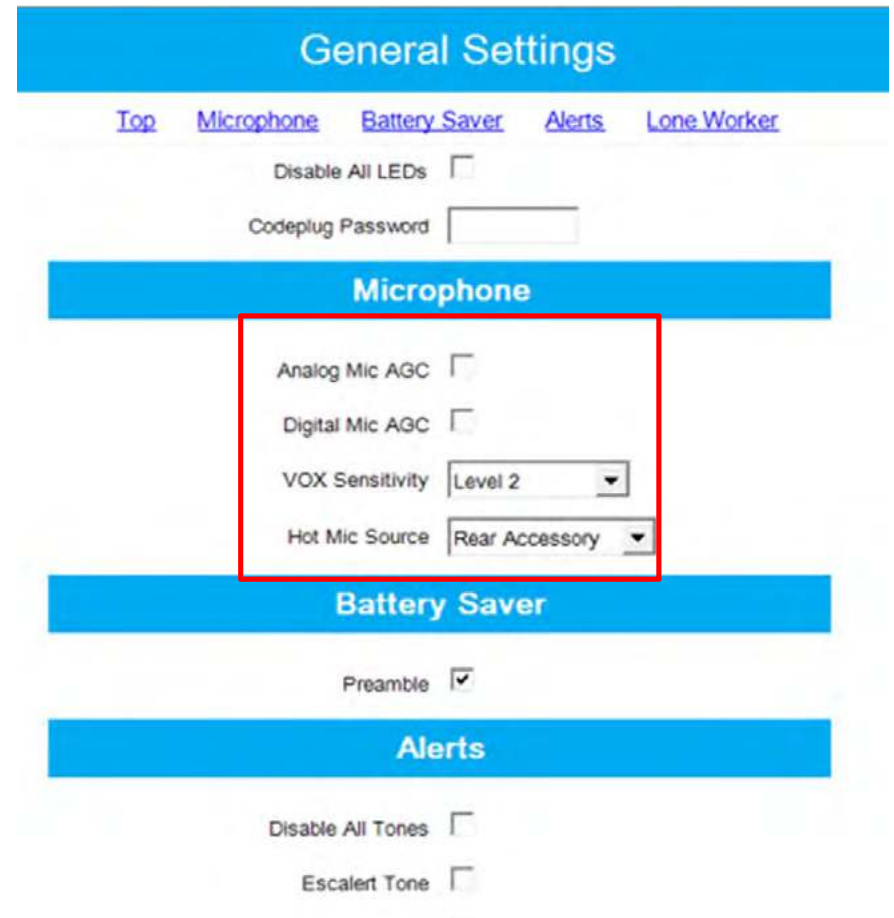

XMC-M26 Mototrbo Set-up P 3/4



Conventional & Connect Series

Under Accessories

-Set RX Audio type to : Filtered Squelch

Now Select GPIO Physical Pins

- Set Pin# 17 to Ext Mic PTT*

-Active level Low

-Set Pin #21 to PL/Talkgroup Detect*

-Active level : Low

* not applicable to Connect Series

Accessories

[Top](#) [GPIO Physical Pins](#) [Horn & Lights](#)

Volume Control

Ignition Sense

Analog Front Mic Gain (dB)

Digital Front Mic Gain (dB)

Analog Rear Mic Gain (dB)

Digital Rear Mic Gain (dB)

RX Audio Type

Data Revert Channel

Debounce Duration (ms)

Cable Type

Accessories

[Top](#) [GPIO Physical Pins](#) [Horn & Lights](#)

GPIO Physical Pins

	Feature	Active Level	Debounce
Pin #17	Ext Mic PTT	Low	<input checked="" type="checkbox"/>
Pin #19	Monitor	Low	<input checked="" type="checkbox"/>
Pin #20	Unassigned	High	<input checked="" type="checkbox"/>
Pin #21	PL/Talkgroup Detect	Low	<input checked="" type="checkbox"/>
Pin #22	Unassigned	Low	<input checked="" type="checkbox"/>
Pin #24	Unassigned	Low	<input checked="" type="checkbox"/>
Pin #26	Ext Alarm/Horn & Lights	High	<input checked="" type="checkbox"/>

Horn & Lights

Alarm

XMC-M26 Connect Series Set-up P 4/4



Note: Both the MOTOTRBO CPS and Connect Series Option Board CPS must be used to program Pin 17. The two programs are independent of each other.

Mototrbo CPS: Pin #17 select "Generic Input 1"

Connect Series CPS: Generic Input #1 select "External PTT"

Mototrbo CPS under "Accessories"

GPIO Physical Pins

	Feature	Active Level	Debounce
Pin #17	Generic Input 1	Low	<input checked="" type="checkbox"/>
Pin #19	Monitor	Low	<input checked="" type="checkbox"/>
Pin #20	Unassigned	High	<input checked="" type="checkbox"/>
Pin #21	PL/Talkgroup Detect	Low	<input checked="" type="checkbox"/>
Pin #22	Unassigned	Low	<input checked="" type="checkbox"/>
Pin #24	Unassigned	Low	<input checked="" type="checkbox"/>
Pin #26	Ext Alarm/Horn & Lights	High	<input checked="" type="checkbox"/>

Connect Series Option Board CPS under "Accessories"

Accessories

Generic Inputs/Outputs

Connect Plus Feature	
Generic Input #1	External PTT
Generic Input #2	None
Generic Input #3	None
	Generic Outp
	Generic Outp
	Generic Outp

Connect Plus: In Option Board CPS:
**In "General Settings": Leave Hot Mic Source Front
Accessory**

General Settings

Radio ID 33509

Enable Privacy Settings

Microphone

Hot Mic Source Front Accessory

Tones/Alerts

Disable All

Talk Permit

XCA-M26T Cable Adaptor: for Motorola MTM5400/5200 TETRA radio etc series



Female RJ45 shielded

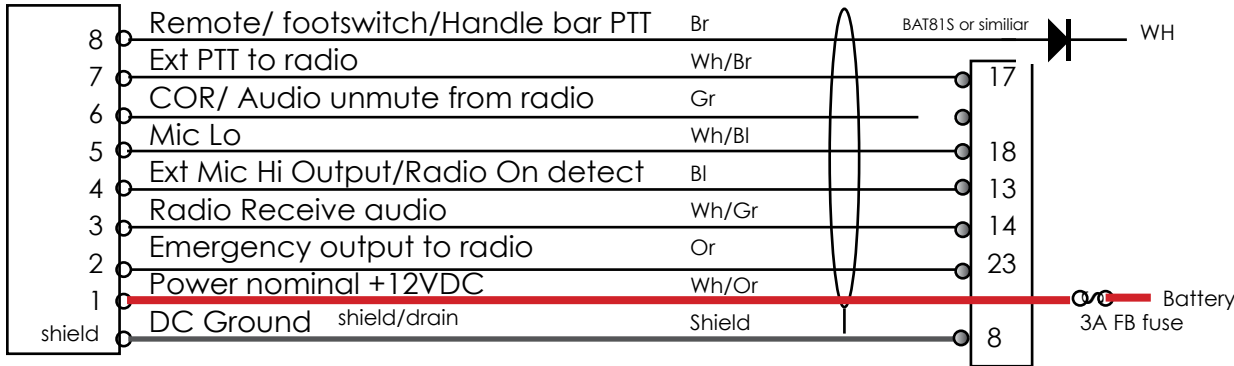

Motorola MTM 26 Pin

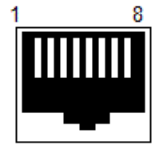

Front View

Receptacle

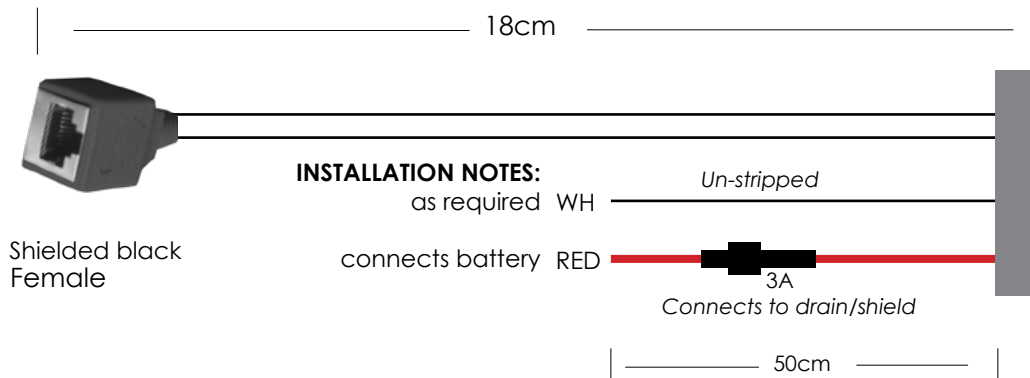

Shielded black Female

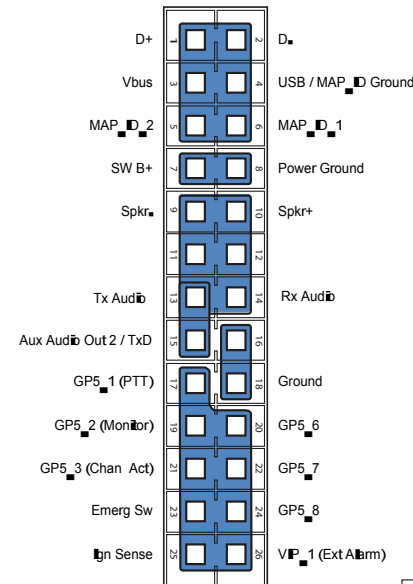

Rear View



Copyright WCL 2020

Date: May12th 2017 Revision: 2

XCA-M26T Cable Adaptor: for Motorola MTM5400 TETRA radio etc series Radio CPS Programming requirements:

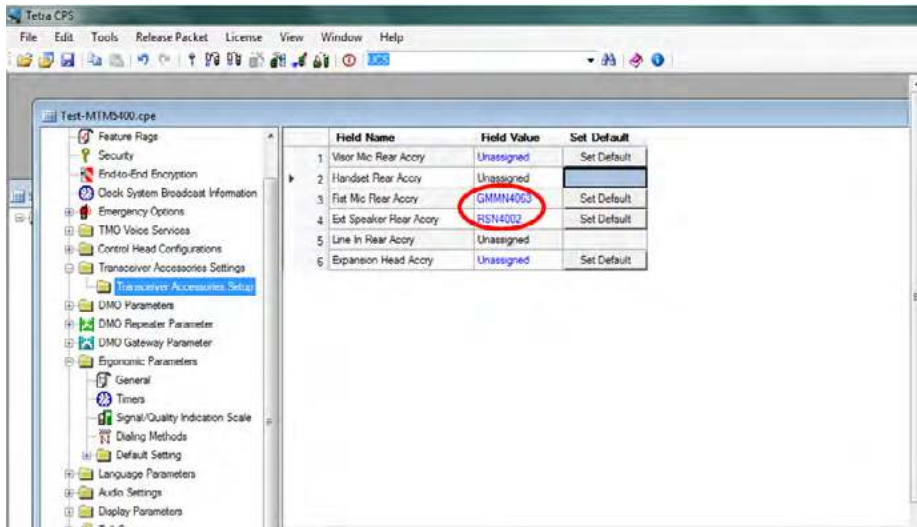

Go to Transceiver Accessory Set-up:
-Select GMM4063
-Select RSN4002

Go to Transceiver Accessory Settings:
-Set RX Audio Line output to 0dB

Go to Emergency Call options:
-Tick Exit Emergency Mode... box

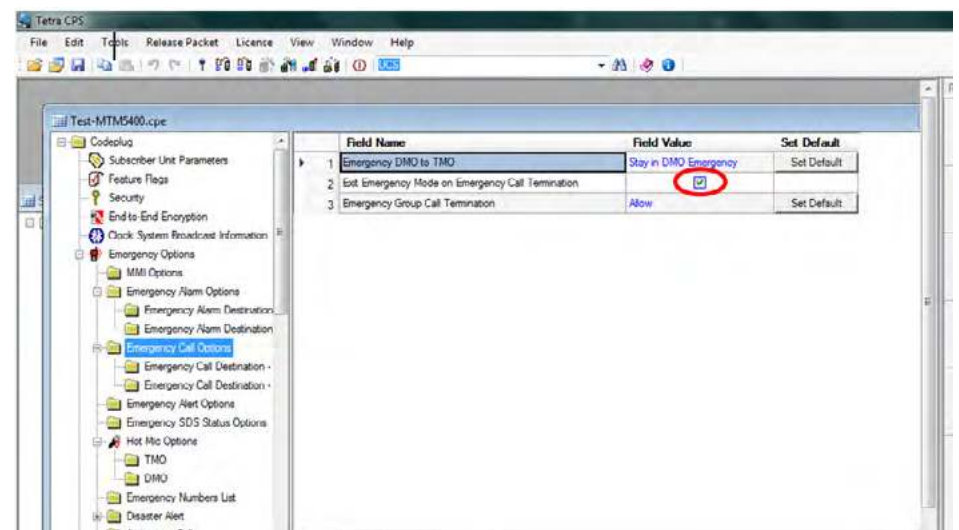
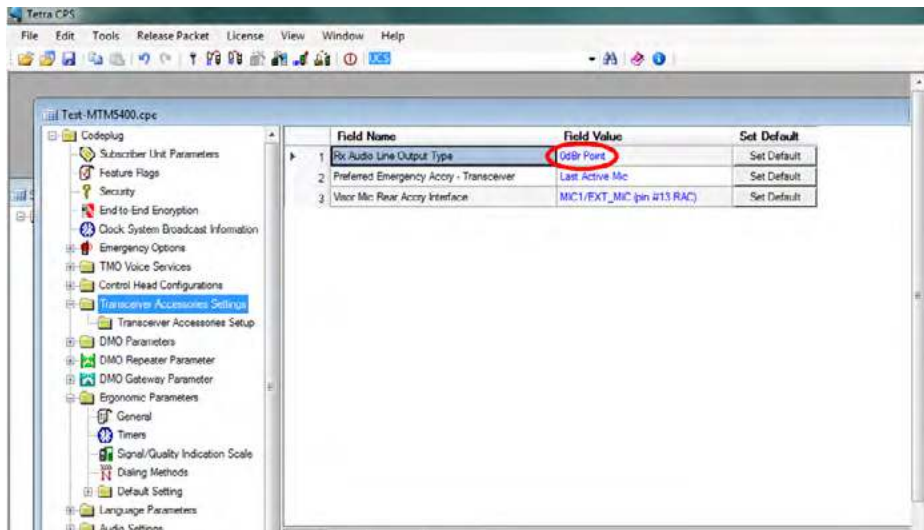

XCA-M16 Cable Adaptor:

For Motorola GM360/MCX/PM400/CDM etc



Female RJ45 shielded

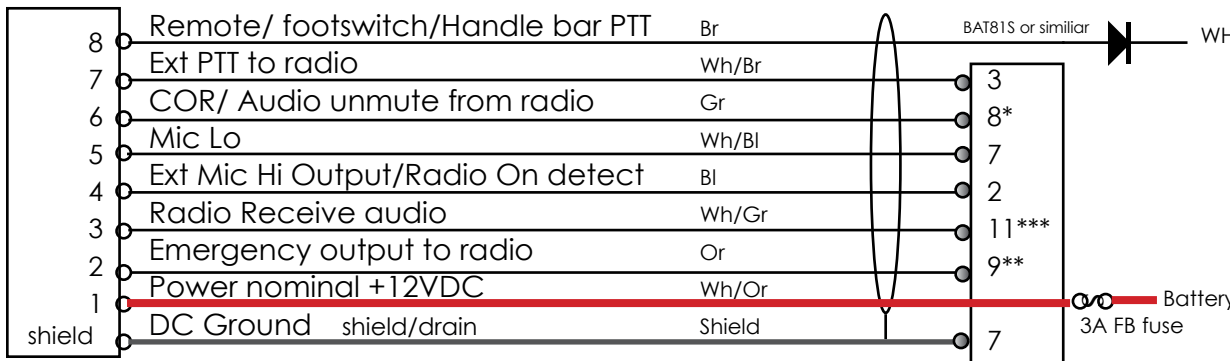

Motorola 16 Pin

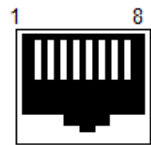

Front View

Receptacle

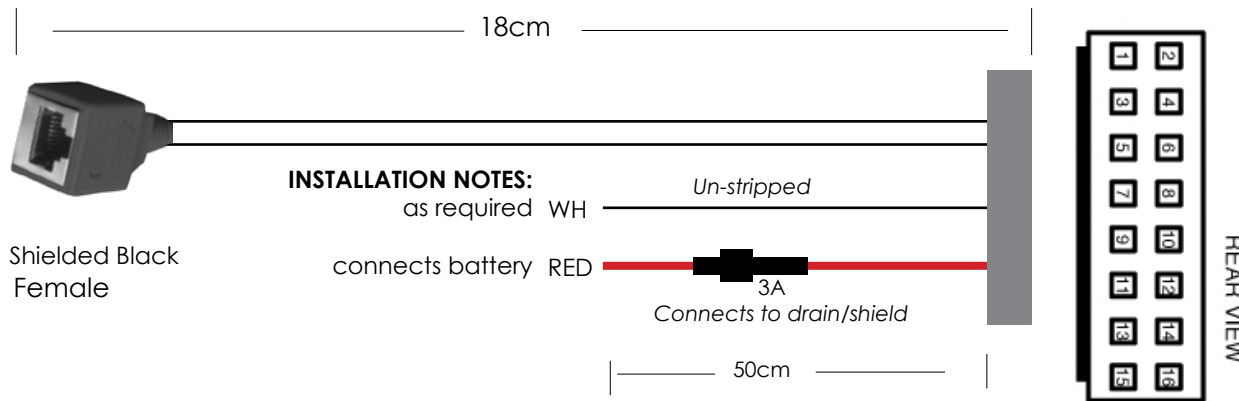

Note:

Motorola have over the years used the 16 pin connector on a wide variety of models. You should check the radio programming and/or jumpering to ensure correct operation of the X10DR unit.

* Pin 8 or Pin 4: COR availability depends on model. Connect ONLY if available

** Pin 9: may need programming for Emergency.

*** Pin 11: Audio should be set for pre-emphasis and gated where applicable by either programming or hardware jumper as applicable. If gated audio is not available, turn OFF VOX function on X10DR gateway is only other option however COR MUST be connected, be aware occasional noise burst may sound in Secure Mic depending on radio's COR performance.

BEWARE:

before attempting connection for **GTX/LTS** refer their specific service manual.



Copyright WCL 2020

Date: Jan12th 2018 Revision 2

XCA-M16T Cable Adaptor: For Motorola MTM800 TETRA Radio



Female RJ45 shielded

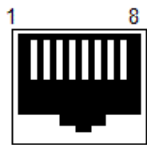
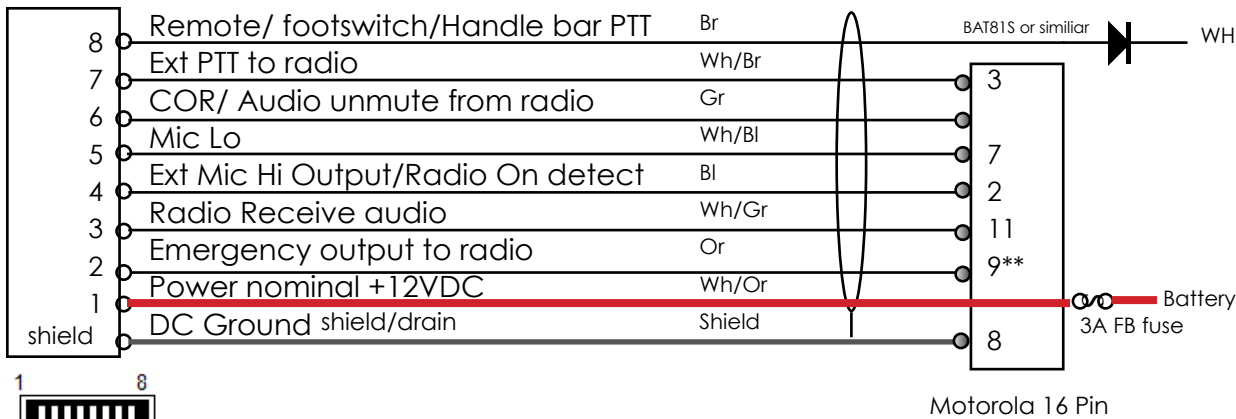

Front View

Receptacle

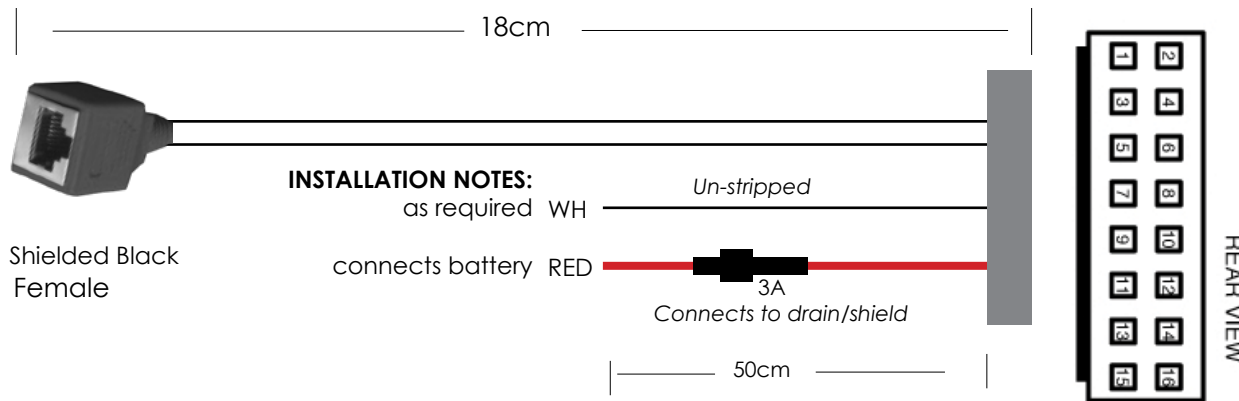

Note:

Motorola have over the years used the 16 pin connector on a wide variety of models. You should check the radio programming and/or jumpering to ensure correct operation of the X10DR unit.

**Emergency function needs to be programmed into the radio and Pin 9 assigned to become operational.



Copyright WCL 2020

Date: Aug12th 2019 Revision:0

XCA-APX cable adaptor: for Motorola APX/XTL series includes 26 Pin connector

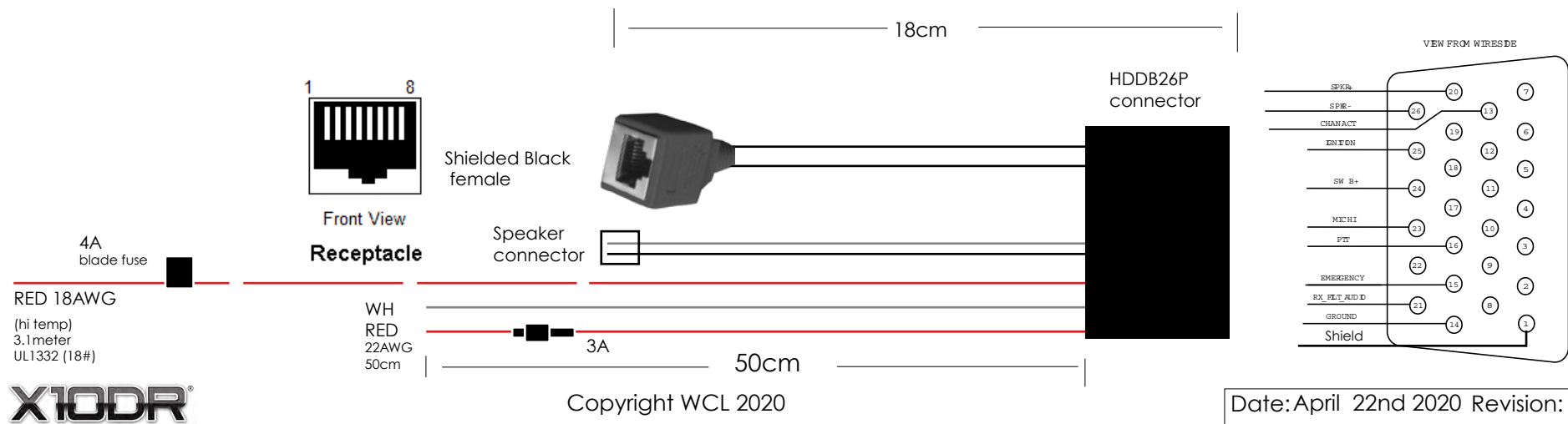
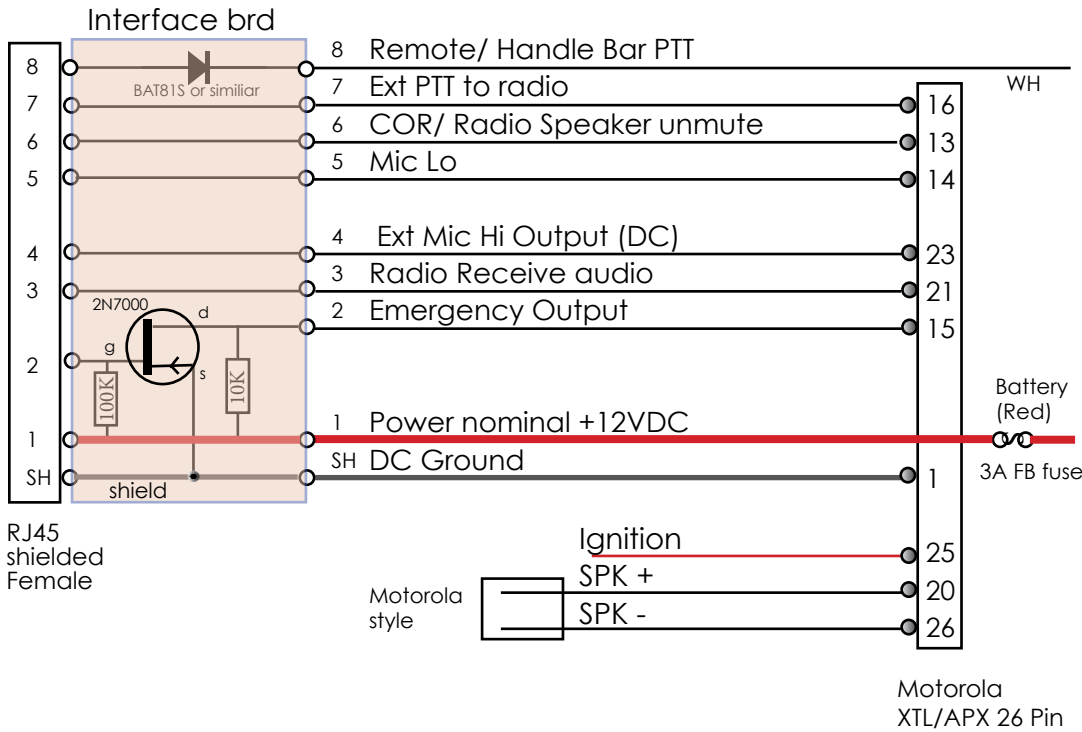

Copyright WCL 2020

Date: April 22nd 2020 Revision: 4

XCA-VM9 Interface cable:

for Kenwood/EFJViking VM900
Male DB25 for EFJ pigtail UDDI/PVP



Notes:

Program radio connector
 pin 4: Emergency Input

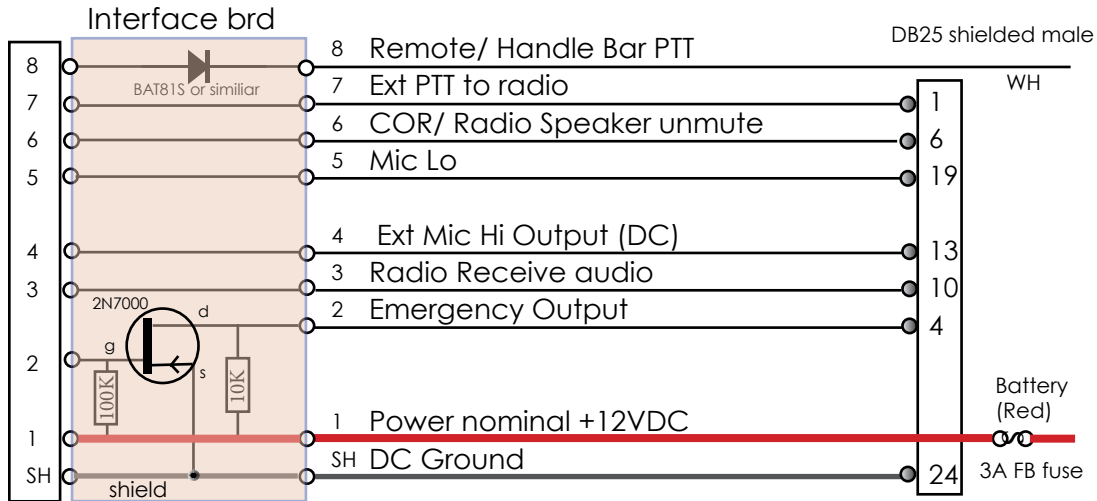

RJ45 shielded to DB25 - Male
 molded style

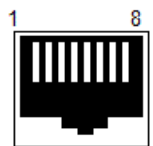

Front View
 Receptacle

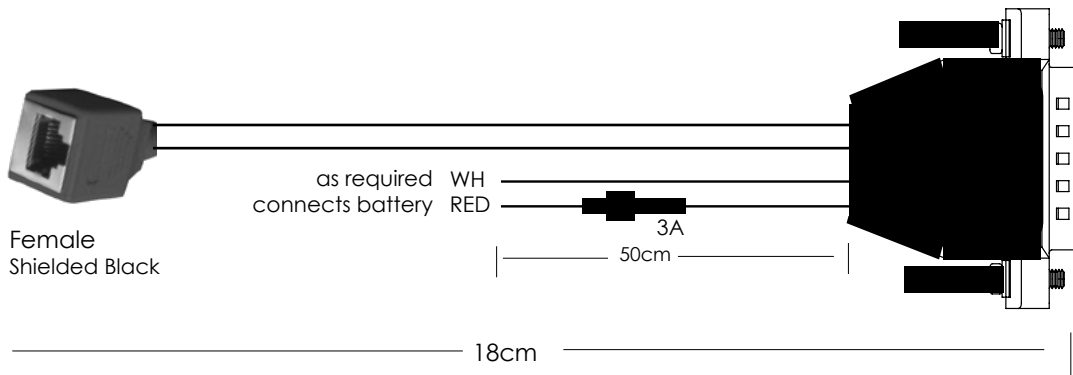

XCA-K25 cable adaptor:

for Kenwood NX700,TK5710, TK5720, TK8180
Viking VM5000, etc



Notes:
Program radio pins :
4 : PTT
8 : Emergency
24 : Squelch indicate

Set external Mic sensitivity for "low" when available in the field programmer.

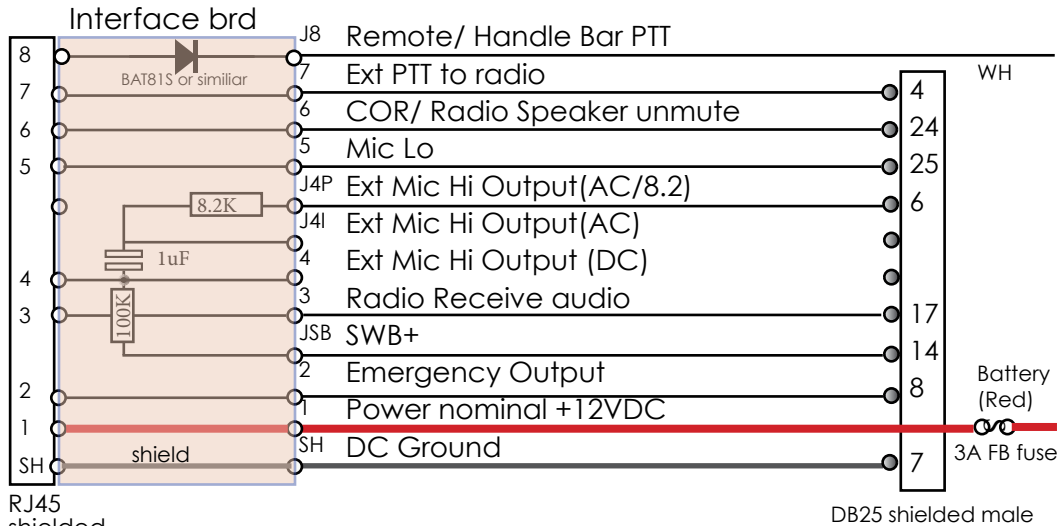

RJ45 shielded Female

DB25 shielded male

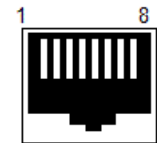

Front View

Receptacle

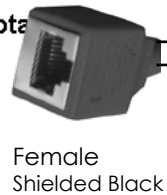

Female Shielded Black

as required WH connects battery RED Un-stripped

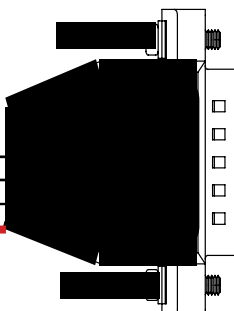

RJ45 shielded to DB25 - Male molded style

18cm



NX700/800 Programming info P 1/3

On Extended Function/Aux window set :



DB24 Pin 4: I/O = Input,	Function = Ext PTT (voice)	Active = Low,	Debounce=Yes
DB24 Pin 8: I/O = Input,	Function = Emergency	Active = Low,	Debounce=Yes
DB24 Pin 24: I/O = Output,	Function = TOR,	Active = Low	

The screenshot shows the X10DR software interface with the 'Extended Function' window open. The window title is 'Extended Function' and it has tabs for 'Optional Board', 'AUX', 'Remote Zone-CH/GID', 'Modulation Line', and 'Mobile Function'. The 'AUX' tab is selected, showing a table of pin configurations and various control options.

Pin number	I/O	Function	Active	Debounce
DB-25 4pin	Input	External PTT (Voice)	Low	Yes
DB-25 8pin	Input	Emergency	Low	Yes
DB-25 12pin	Input	None	Low	No
DB-25 13pin	Input	None	Low	No
DB-25 15pin	Output	None	Low	No
DB-25 16pin	Output	None	Low	No
DB-25 20pin	Output	None	Low	No
DB-25 21pin	Input	None	Low	No
DB-25 22pin	Output	None	Low	No
DB-25 23pin	Input	None	Low	No
DB-25 24pin	Output	TOR	Low	No

Below the table, there are several control sections:

- AUX Input:** Data Dwell Time [s] 0, Mic Sense 0dB (Normal), Debounce Time [ms] 10, Data Override.
- Mic Mute:** Front Mic, MI2.
- AUX Output:** LOK Logic Signal Continuous, AUX Output Status Message: State Hold Timer (Active Low) [s] Off, Status Memory.

NX700/800 Programming info P 2/3



On Extended Function/Modulation Line window set :

Mic PTT Mic Line = Connect, Mi2 = Disconnect, DI Line =Disconnect,
 Ext PTT Mic Line = Disconnect, Mi2 = Connect, DI Line =Disconnect ,

With QT/DQT=Yes,
 With QT/DQT=Yes,

With STE=Yes
 With STE=Yes

PTT	Connect to Modulation Line			With QT/DQT	With STF
	Mic Line	Mi2 Line	DI Line		
Mic PTT	Connect	Disconnect	Disconnect	Yes	Yes
External PTT (Voice)	Disconnect	Connect	Disconnect	Yes	Yes
External PTT (Data)	Disconnect	Disconnect	Connect	Yes	Yes
Data PTT	Disconnect	Disconnect	Connect	Yes	Yes

Modulation Line by Mic PTT

On Extended Function/Mobile Function window set :

DI level = -1
 DEO level = +4

DI Level -1

DEO Level +4

It is recommended to set the mic sensitivity on the MI2 line to Low (-10dB) when radio firmware release allows.

Adjust VR1 trimpot (carefully) on base of Charger cradle so audio from X10DR microhone is the same as when you talk into the radios wired fist mic.

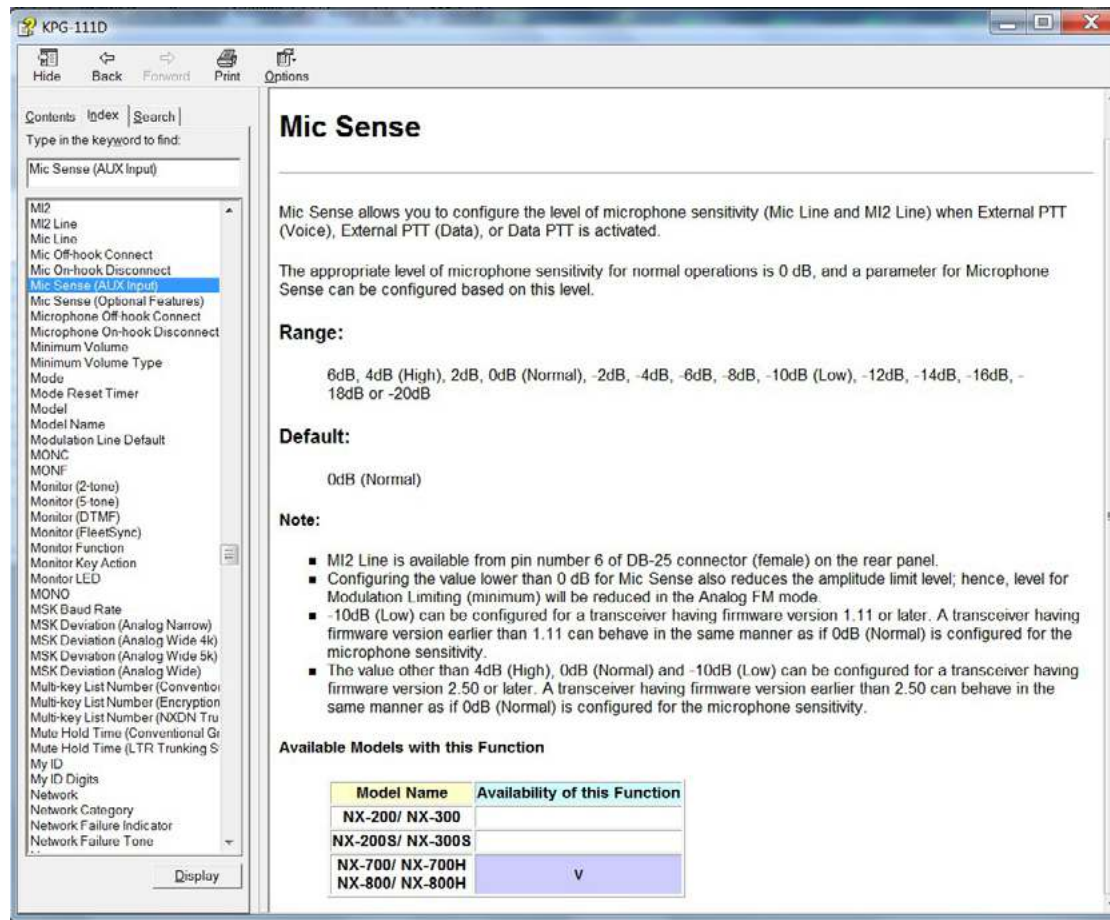

The screenshot shows a web-based programming interface for a KPG-111D device. The left sidebar contains a list of configuration options, with 'Mic Sense (ALX Input)' selected. The main content area is titled 'Mic Sense' and provides detailed information about microphone sensitivity settings.

Mic Sense

Mic Sense allows you to configure the level of microphone sensitivity (Mic Line and MI2 Line) when External PTT (Voice), External PTT (Data), or Data PTT is activated.

The appropriate level of microphone sensitivity for normal operations is 0 dB, and a parameter for Microphone Sense can be configured based on this level.

Range:

6dB, 4dB (High), 2dB, 0dB (Normal), -2dB, -4dB, -6dB, -8dB, -10dB (Low), -12dB, -14dB, -16dB, -18dB or -20dB

Default:

0dB (Normal)

Note:

- MI2 Line is available from pin number 6 of DB-25 connector (female) on the rear panel.
- Configuring the value lower than 0 dB for Mic Sense also reduces the amplitude limit level; hence, level for Modulation Limiting (minimum) will be reduced in the Analog FM mode.
- 10dB (Low) can be configured for a transceiver having firmware version 1.11 or later. A transceiver having firmware version earlier than 1.11 can behave in the same manner as if 0dB (Normal) is configured for the microphone sensitivity.
- The value other than 4dB (High), 0dB (Normal) and -10dB (Low) can be configured for a transceiver having firmware version 2.50 or later. A transceiver having firmware version earlier than 2.50 can behave in the same manner as if 0dB (Normal) is configured for the microphone sensitivity.

Available Models with this Function

Model Name	Availability of this Function
NX-200/ NX-300	
NX-200S/ NX-300S	
NX-700/ NX-700H	v
NX-800/ NX-800H	

XCA-K25M Interface cable:

for Kenwood TK690/790, etc series
can be modified for other models



Notes:
Program radio I/O pins :
4 : PTT
5 : Emergency

Refer Kenwood TK690 service manual.
Pin 13 ships from the factory as a Data input. Swapping the 0 ohm resistor from R641 to R640 changes pin 13 to the required analog Mic Hi input.

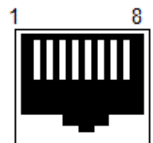
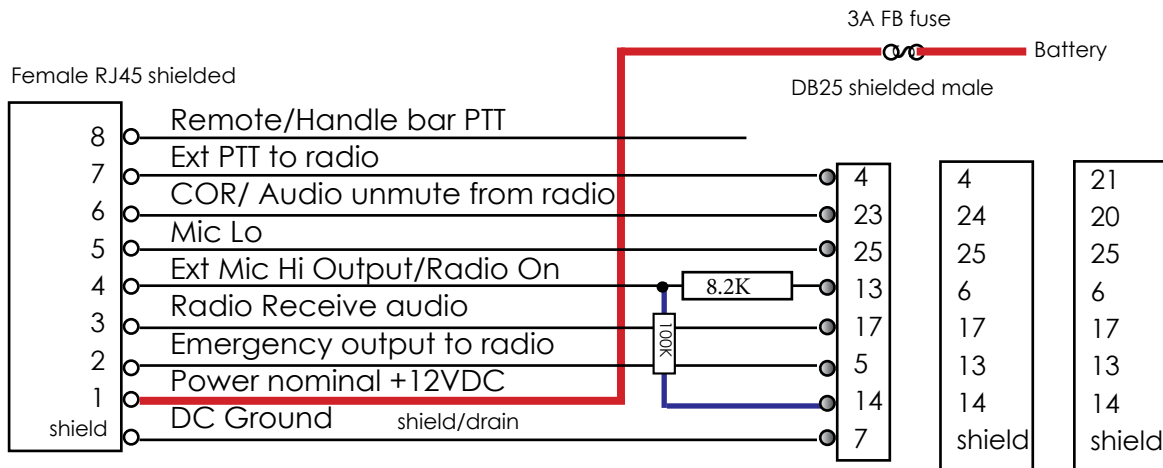

Front View
Receptacle

DEFAULT
Pin Outs
TK690/
TK590/
etc

Pin Outs
NX700
TK8180/
TK5710/
etc

Pin Outs
TK8150
etc

TK-*90 Radio Control Unit PCB

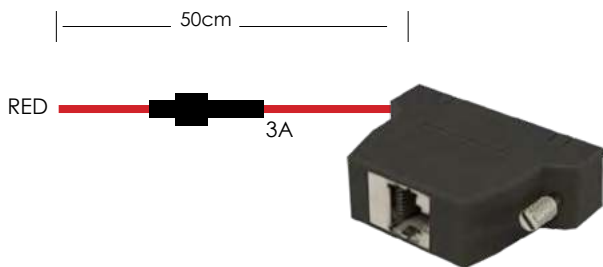
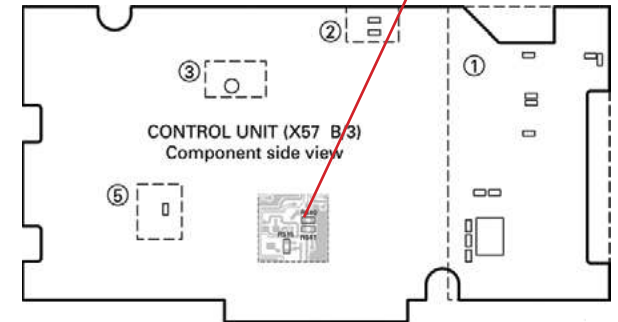

RJ45 shielded to DB25
- Male

XCA-K25N cable adaptor:

for Kenwood NX700 / TK5710, TK5720, TK8180 etc
can be modified for other models



Notes:
Program radio pins :
4 : PTT
8 : Emergency
24 : Squelch indicate

Set external Mic sensitivity for "low" when available in the field programmer.

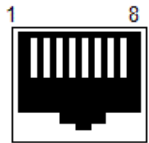
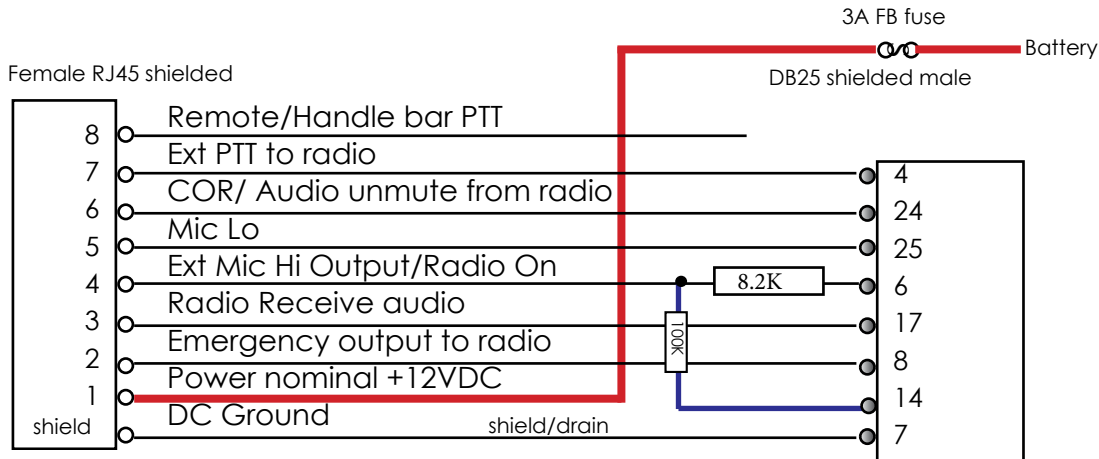

Front View
Receptacle

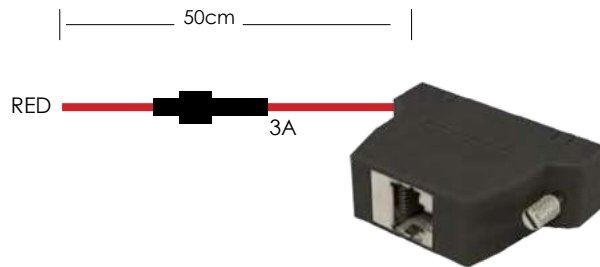

RJ45 shielded to DB25
- Male



XCA-**M Modification Instructions

The XCA type 2 Interface adaptors may be modified to change or add custom wiring to suit specialised applications or to use with radios not currently supported for mass production of This document shows how to perform such modifications.

Step 1 : Separate the connector from the housing:
Slide a pair of tweezers or small flat blade screwdriver behind the connector while, at the same time opening the clips either side of the housing – as shown below:

Once one side is loose, do the same for the other side.

Then carefully pull out the connector to expose the pins.
Take care not to pull the connector assembly out too far and break any connections:

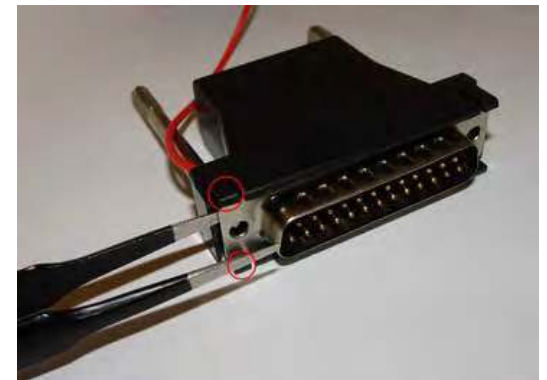

XCA-**M Modification Instructions (cont)

Step 2 : Thread wire and prepare Thread the new wire through one of the access holes either side of the thumbscrews. Leave about 40mm (1½") inside the connector. Remove the hot melt glue from the desired pin:

Step 3 : Solder, Re-apply Glue and Re-assemble: Solder (or change) desired wire(s), then apply hot-melt glue over the contact and wire to ensure joints remain secure in heavy vibration environments:



Complete



XCA-K15D Cable Adaptor: for Kenwood DB15 cable NX720/NX3720 series

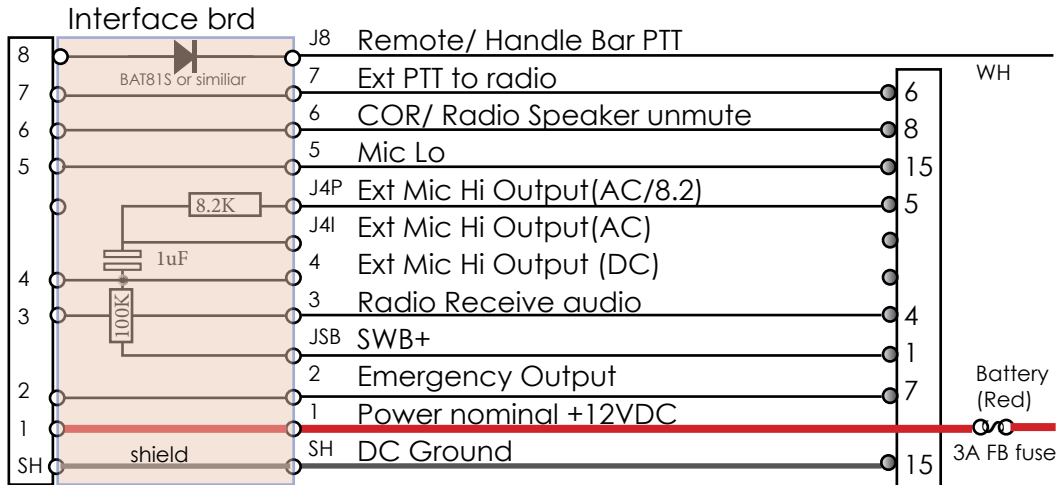

RJ45 shielded Female

DB15HD shielded male

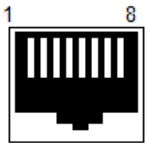

Front View

Receptacle



Female Shielded Black

RJ45 shielded to DB15HD (VGA style) - **Male** molded style

as required WH connects battery RED

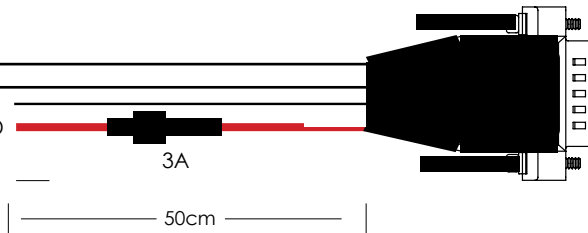

18cm

NOTES:

- Program Radio connector
- 8- I/O COR /TOR out
- 7- I/O Emerg In
- 6 - I/O Ext PTT In

OTHER INSTALL REQUIREMENTS:

NX720 Radios
Move radio chip jumper R796 to R789
Move radio chip jumper R797 to R799

NX3720 Radios
Move radio chip jumper R613 to R612
Move radio chip jumper R659 to R601

TK7360 Radios

??



XCA-K15E Cable Adaptor:

for Kenwood DB15 cable NX740 /TK-D840, series etc

Can be used for: NX720/NX3720 series also.

Note: Radio speaker volume control effects X10DR Loudspeaker audio level.



NOTES:

- Program Radio connector
- 8- I/O COR /TOR out
- 7- I/O Emerg In
- 6 - I/O Ext PTT In

OTHER INSTALL REQUIREMENTS:

NX-740 /840 Radios
Move radio chip jumper R737 to R735

TK-D740/840 radios
Move the R737 chip jumper to R735.

NX720 Radios
Move radio chip jumper R796 to R789
Move radio chip jumper R797 to R799

NX3720 Radios
Move radio chip jumper R613 to R612
Move radio chip jumper R659 to R601

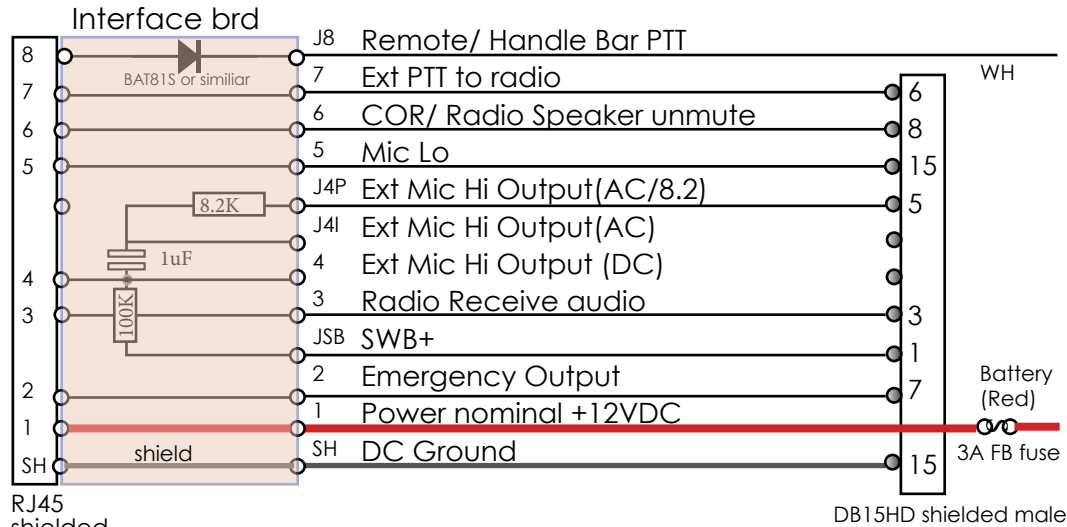

RJ45 shielded Female

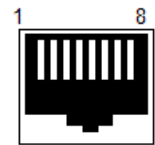

Front View

Receptacle



Female Shielded Black

RJ45 shielded to DB15HD (VGA style) - Male molded style

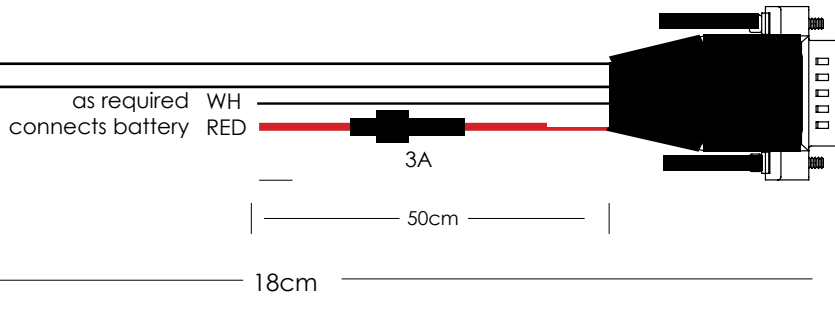

Copyright WCL 2020

Date: Jun 18th 2020 Revision: O

XCA-K15S Cable Adaptor: for Kenwood TK8360/7360 radios

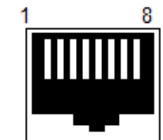
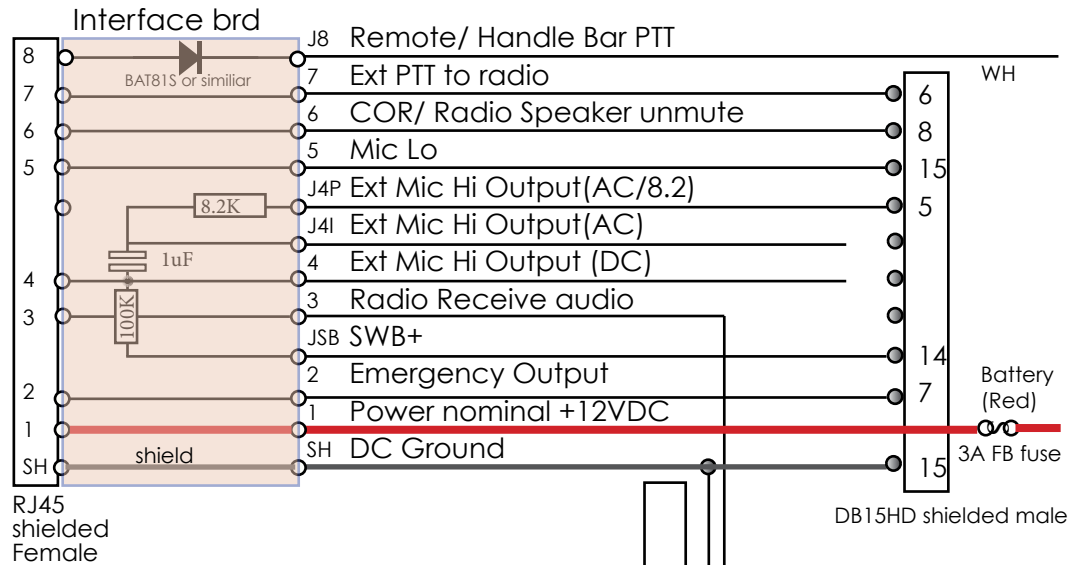

Front View

Receptacle



Female
Shielded Black

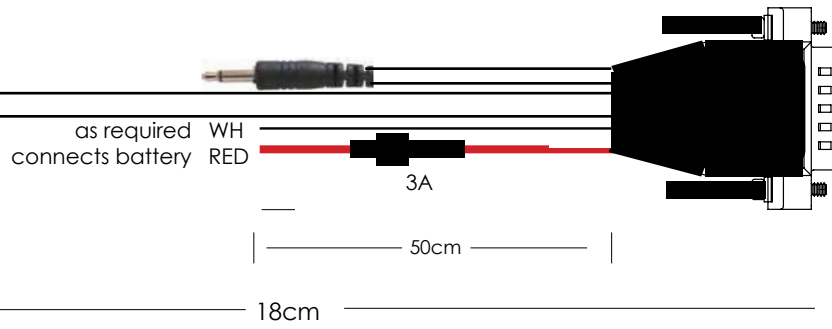

RJ45 shielded to DB15HD
(VGA style)
- **Male** molded style

Notes:

Program Radio connector (RADIO CPS) 8- I/O COR out
7- I/O Emerg In
6 - I/O Ext PTT In

Program X10DR for Speaker NOT muted when placed in cradle. (except if you wish to use external speaker - as below)

Require External Speaker?

Plug dual 3.5 "Y" adaptor into radio speaker socket. Plug 3.5 plug from XCA into one 3.5 jack. Plug radio external spk into other 3.5 jack. Set Radio volume control for normal listening level, then use programmer to adjust X10DR Rx audio level on gateway cradle for desired listening level from X10DR Spk Mic.

Y adaptor sourcing:

<http://www.amazon.com/Headphone-Splitter-Stereo-3-5mm-Adapter/dp/B0002ZPK40> or similar. (can be mono)



XCA-RJK Cable Adaptor: for Kenwood simple low end radios using front RJ45 Microphone socket. (replaces standard radio fist Mic.)

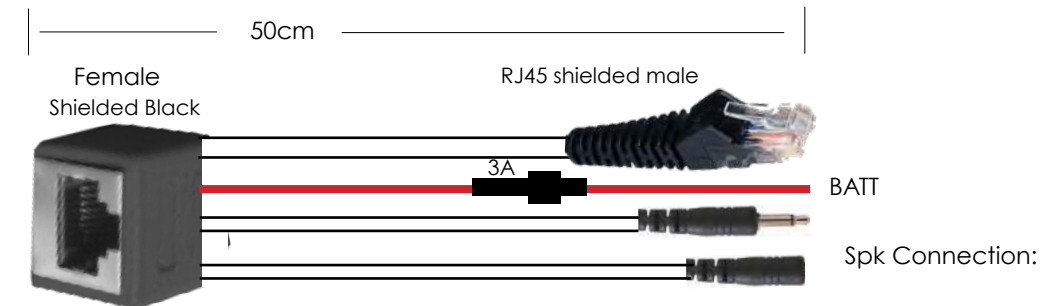
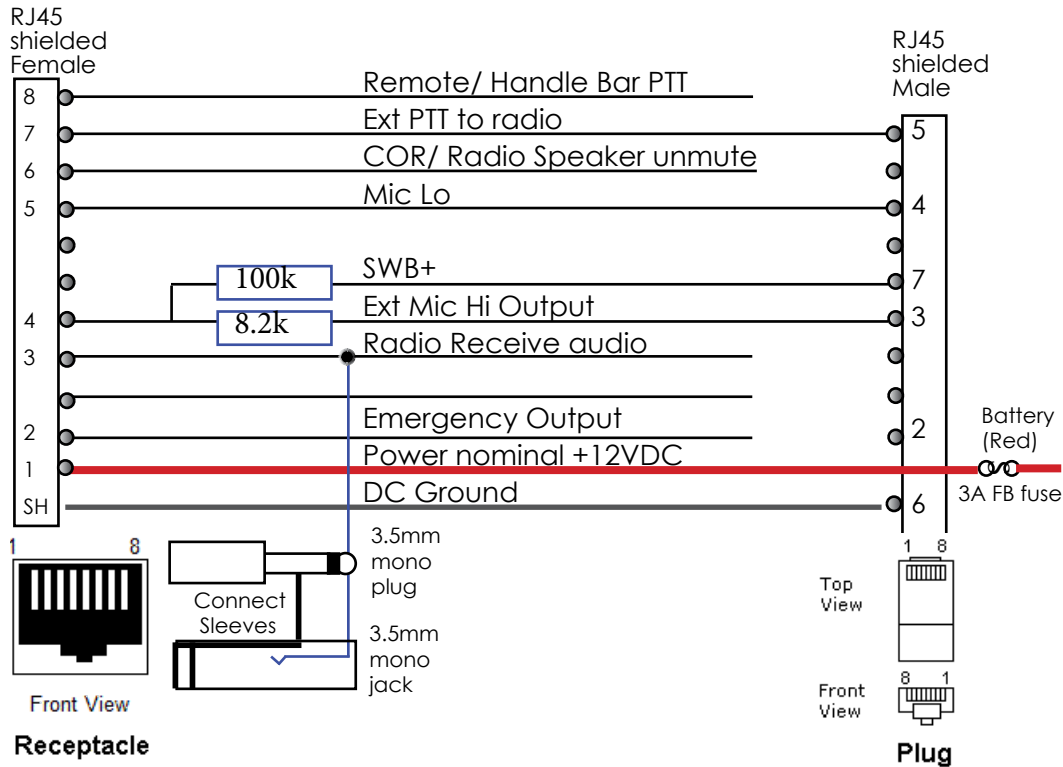

X10DR

shield

Copyright WCL 2020



INSTALLATION NOTES :

Vox Operation

As there is no radio COR (audio unmute indicate) connection available, receive audio is gated in the X10DR handset by VOX. For most users there will be minimal lost audio at the start of each reception.

No Speaker - External Speaker

Plug 3.5mm plug into radio speaker socket.

If desired plug radio external speaker into cable 3.5 jack.

Set Radio volume control for normal listening level, then adjust X10DR Rx audio level on gateway cradle for desired listening level from X10DR Spk Mic.

Alternatively, if you are happy to just use X10DR handset speaker audio to listen to the radio channel and or out of the vehicle then Program X10DR HANDSET for Speaker NOT muted when placed in Cradle.

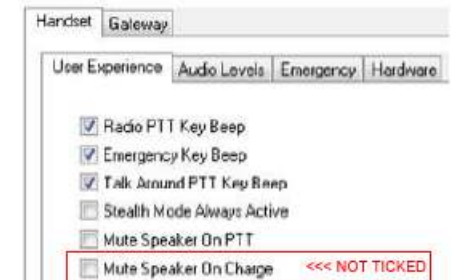

Date: April 24th 2020 Revision: 4

XCA-i25A Cable Adaptor:

for Icom IC-F9511/9521/ 5061/5062 etc

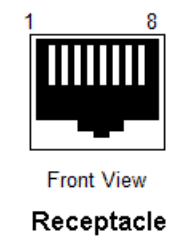
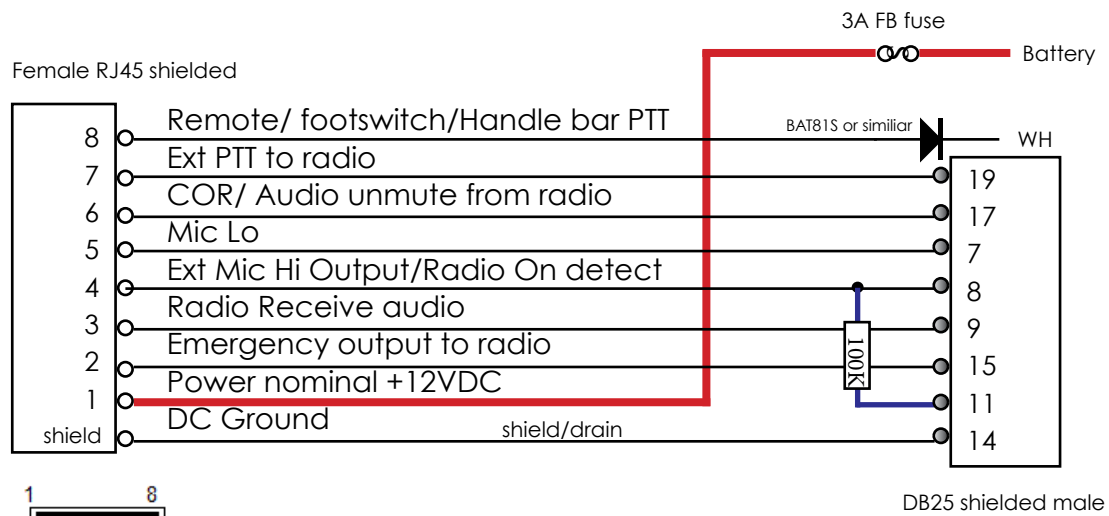

RJ45 shielded to DB25 - **Male**
molded style

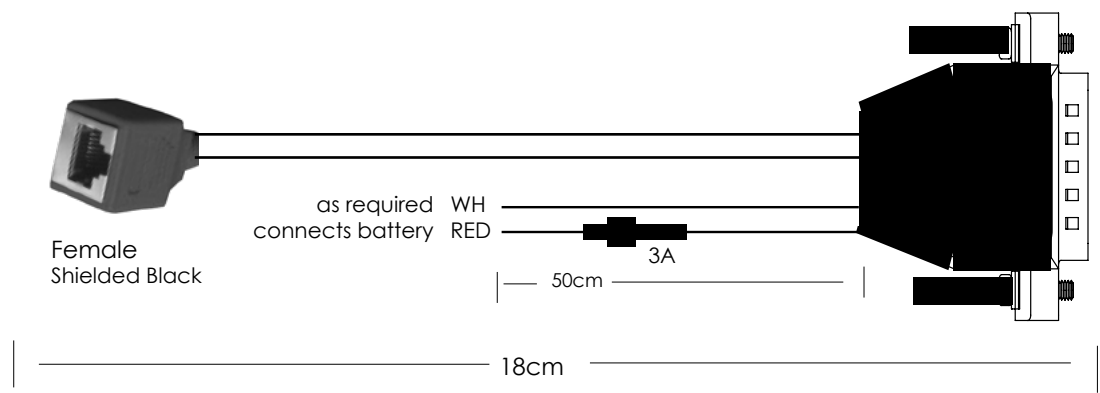

Notes:

Program Radio connector
pin 15: Emergency Input
Pin 17 : Busy
Pin 19: EPTT

COR not connected

IC-F9511/9521 models
'coffee bean' N must be fitted on radio main board to enable Mic audio to connect to Pin 8.

IC-F5061/6062 models
remove coffee bean F and fit coffee bean D.



XCA-i15 Cable Adaptor:

for Icom OPC-1939 adaptor cable
for F5011/F6011/ F5021/F6021/F5121D



Notes:
Program radio pins :
11 - COR out
7 - AF Audio out
4 - Emerg In
14 - Ext PTT

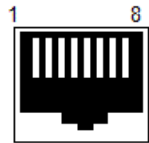
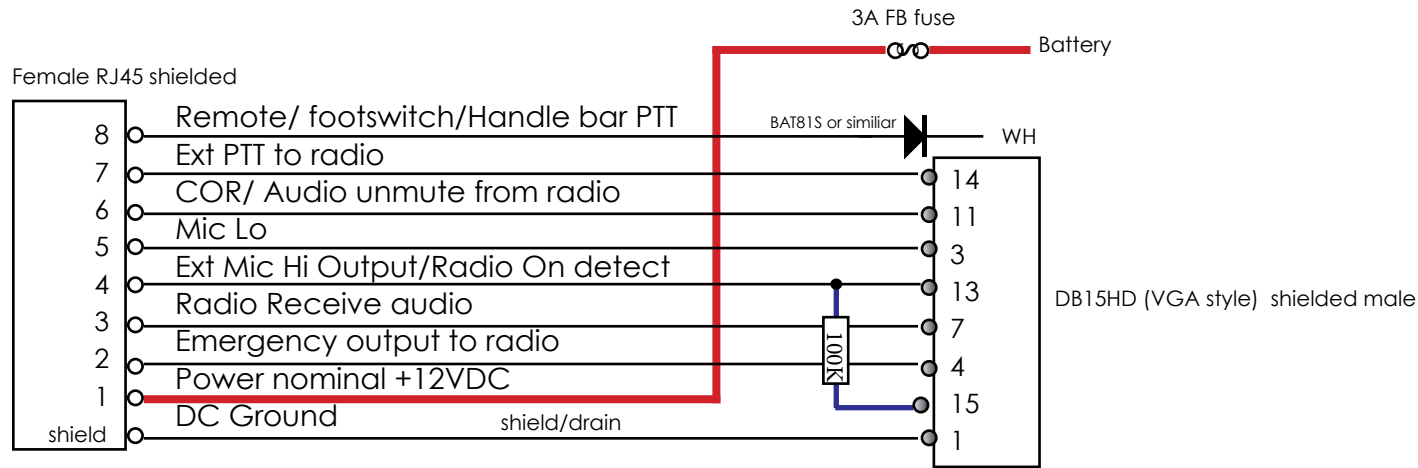

Front View
Receptacle

18cm

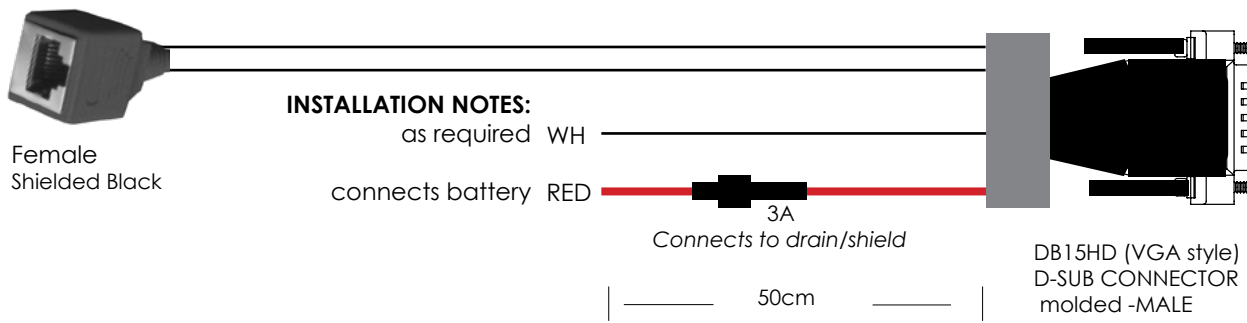

INSTALLATION NOTES:

as required WH
connects battery RED
3A
Connects to drain/shield



Copyright WCL 2020

Date: June 6th 2017 Revision: 2

XCA-RJi Cable Adaptor:

for Icom simple low end radios using front RJ45 Microphone socket (replaces standard radio fist Mic.)

RJ45 shielded Female

RJ45 Male

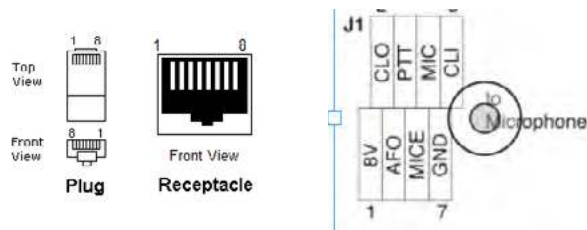
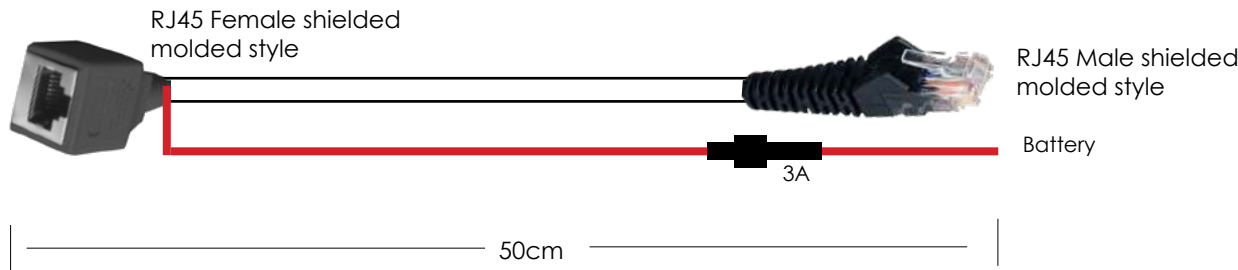
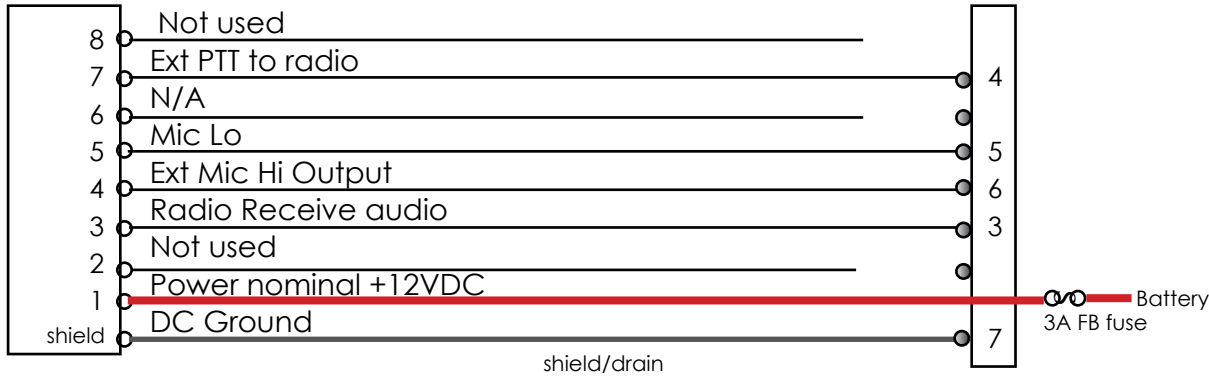

Requires External Speaker

Plug 3.5mm plug into radio speaker socket. Plug radio external spk into cable 3.5 jack. Set Radio volume control for normal listening level, then adjust X10DR Rx audio level on gateway cradle for desired listening level from X10DR Spk Mic.

Note: as there is no radio COR (audio unmute indicate) connection available, receive audio is gated in the X10DR handset by VOX. For most users there will be minimal lost audio at the start of each reception.

May require radio jumper to be fitted

To access radio gated audio on the mobiles Mic input jack you should ensure the AFO jumper (bean) has been fitted if required.

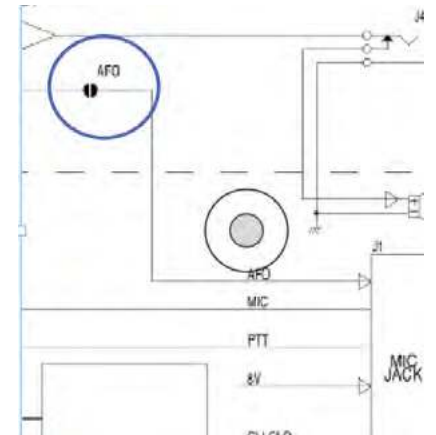

XCA-G25 cable adaptor: for GME P25 Mobile



Notes:
Program radio pins :
11 : Emergency

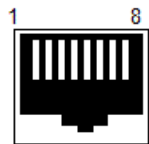
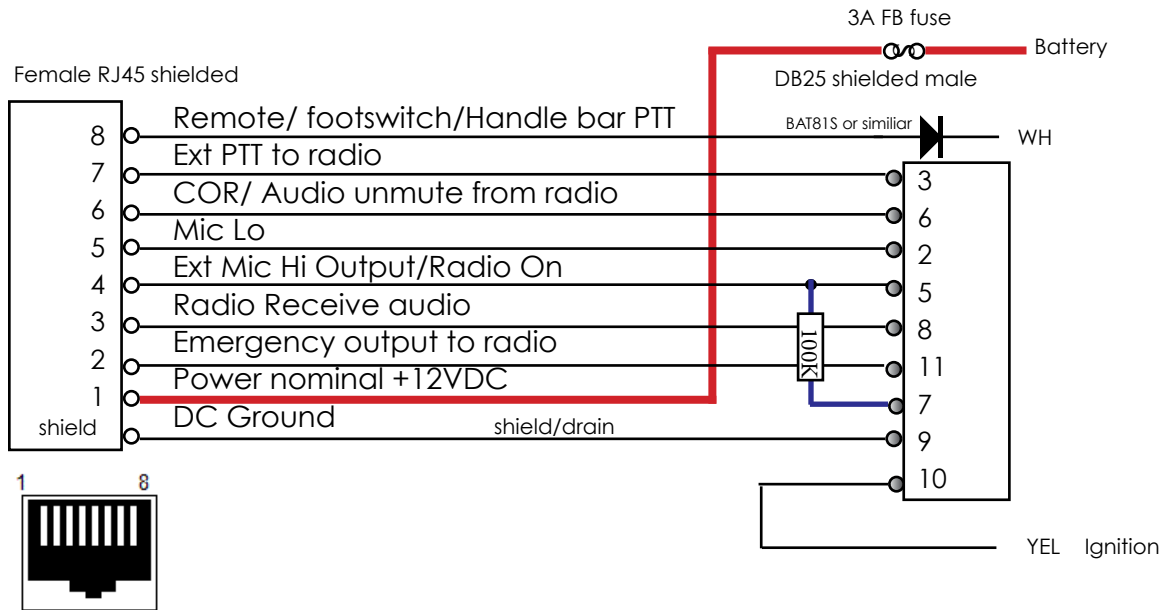

Front View

Receptacle

RJ45 shielded to DB25 - Male
molded style

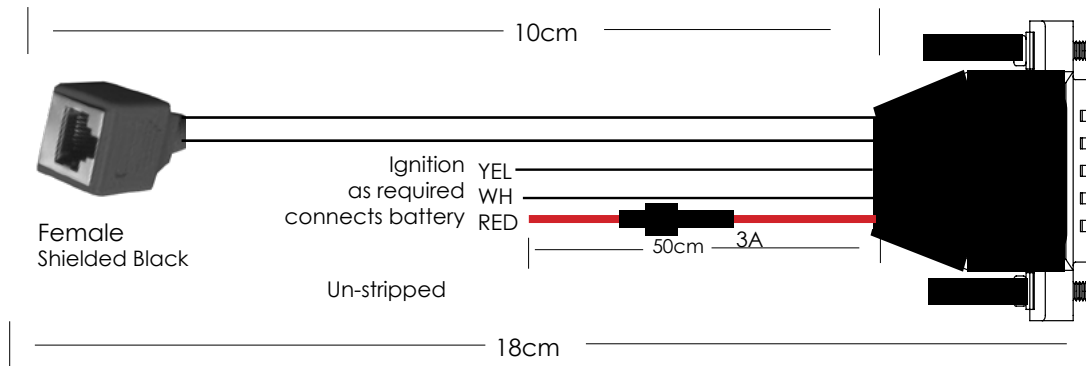

XCA-SD6 Cable Adaptor: for Simoco DMR mobile DB15

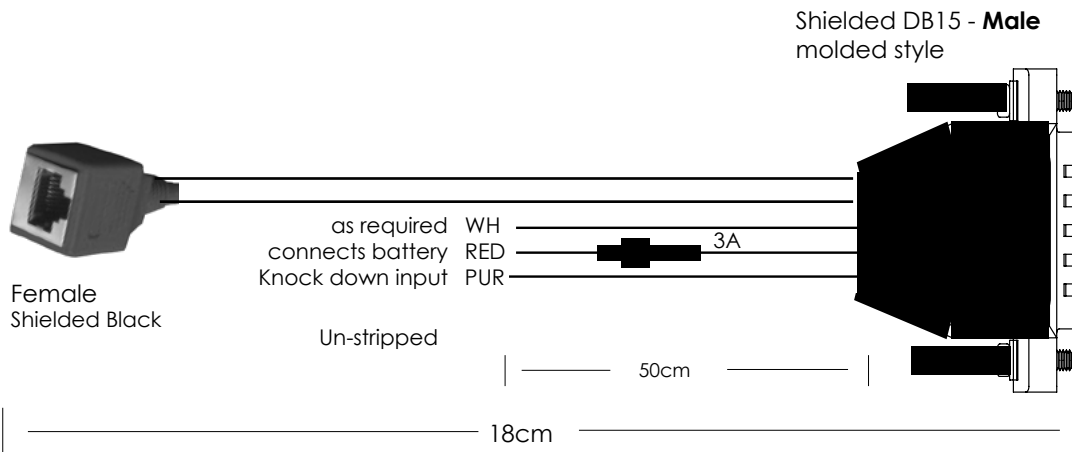
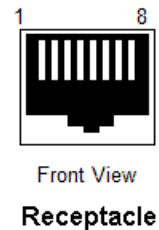
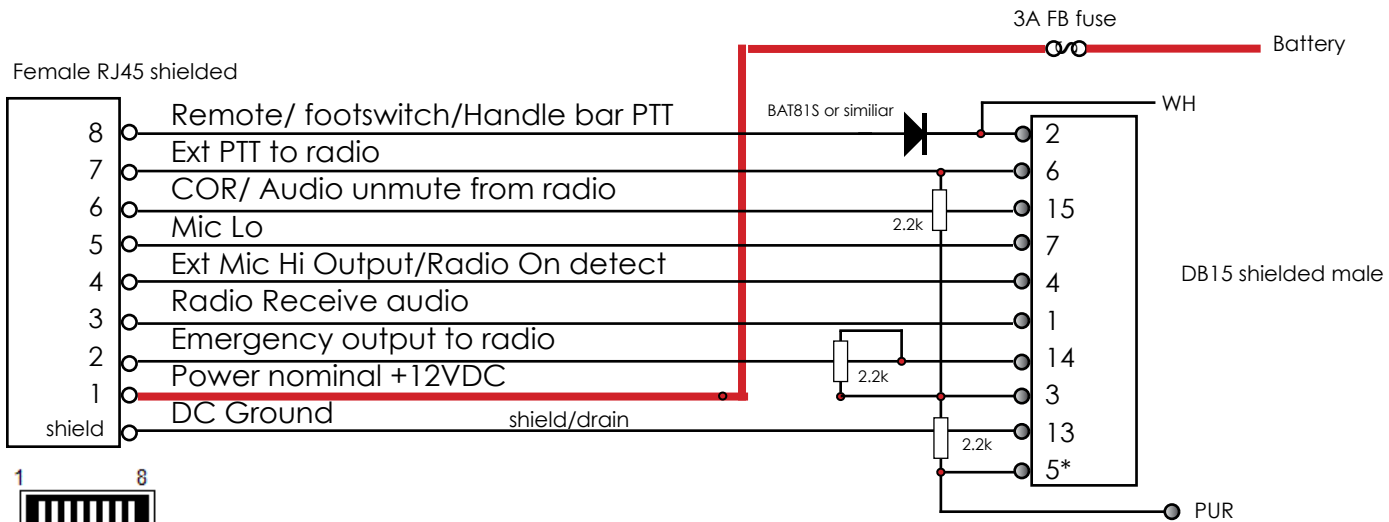

NOTES:

Radio Programming:
Pin 5 Call knockdown*
Pin 6 PTT
Pin 14 Emerg Input
Pin 15 Valid signal

* requires a custom XSJB accessory



SDM600 Programming info P 1/1



Under Settings / Mobile window select "Digital I/Os"

Set MF2 - Input, Function = External PTT, Active = Low, Debounce = 50

Set MF3 - Input, Function = Emergency, Active = Low, Debounce = 50

Set MF4 - Output, Function = Valid Signal, Active = Low, Debounce = 0

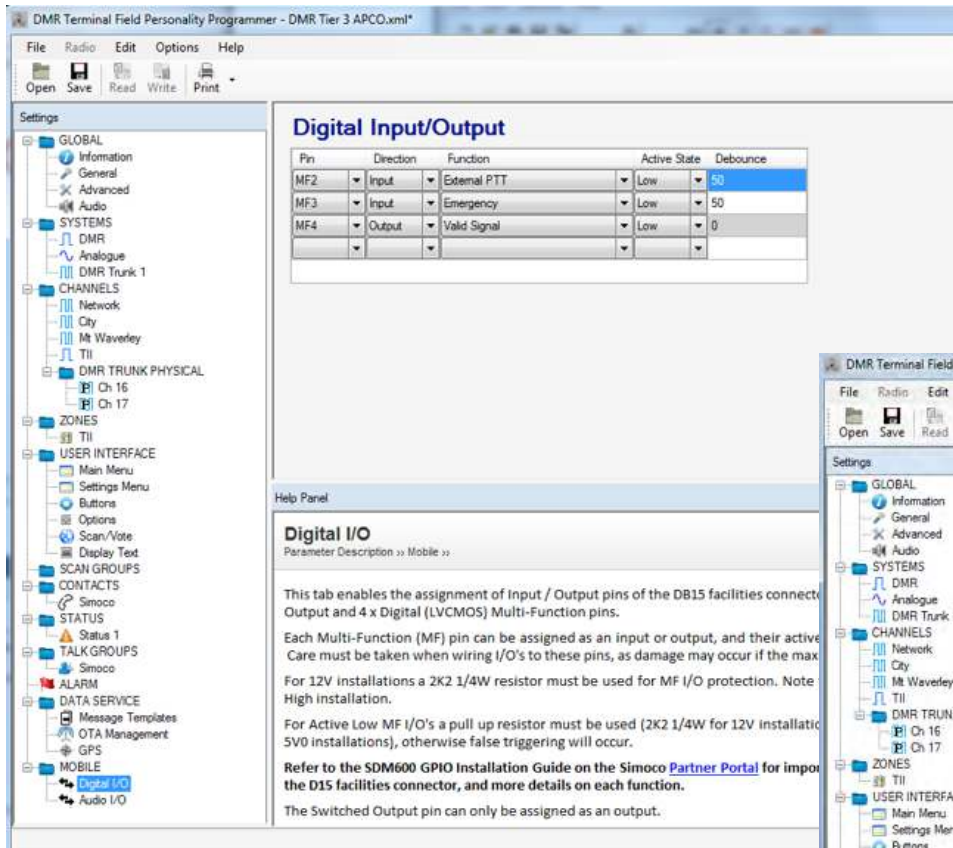

Under Settings / Mobile window select "Audio I/Os"

Set External PTT Input = DB15 Audio in pin, Gain = 0dB

Set Auxiliary Audio Out = DB15 Audio out pin, level = -8dB



XCA-SD7 Cable Adaptor: for Simoco SDM700 mobile DB26-HD-F

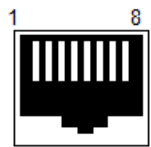
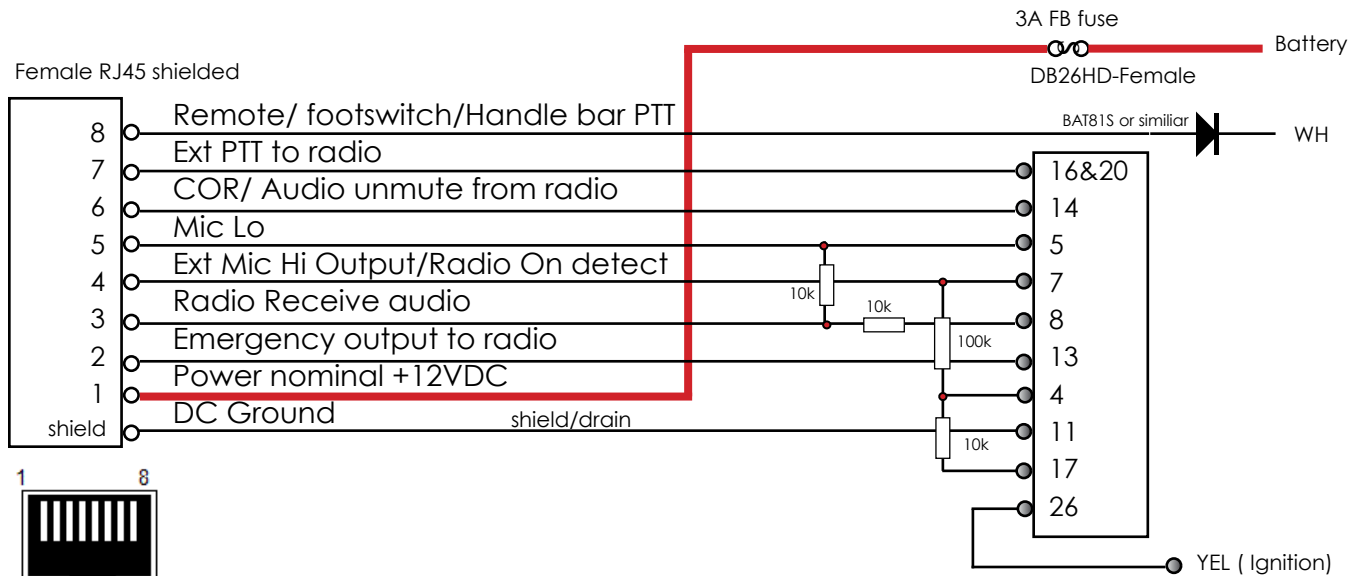

Front View
Receptacle

DB26HD - Female
molded style

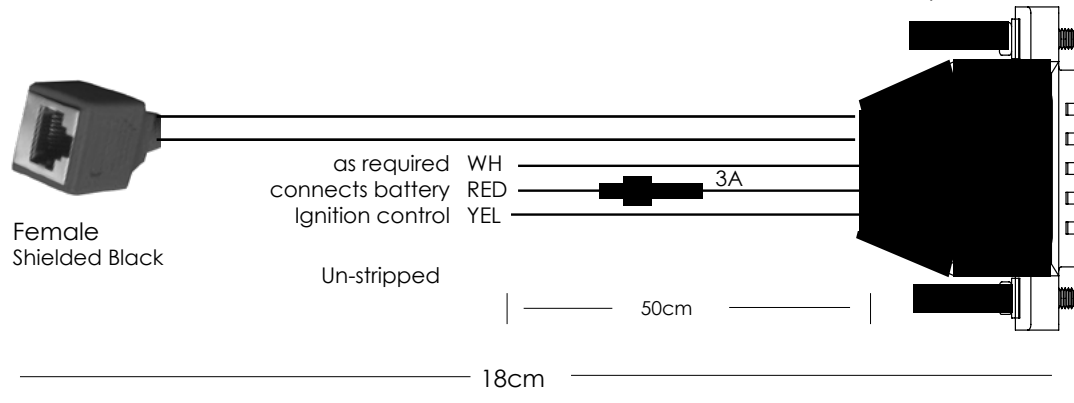

NOTES:

Radio Programming:
PRGM_IO1 = Output, Active Low, Speaker-ON

Yellow is Radio Ignition On/Off control wire.



XCA-SR9 Interface cable: (XCA-XMC & XMC-SRM)

for Simoco SRM 9000 series mobiles
(adds X10DR Interface cable to an existing SRM power cable)



Connects to XCA-XMC included adaptor

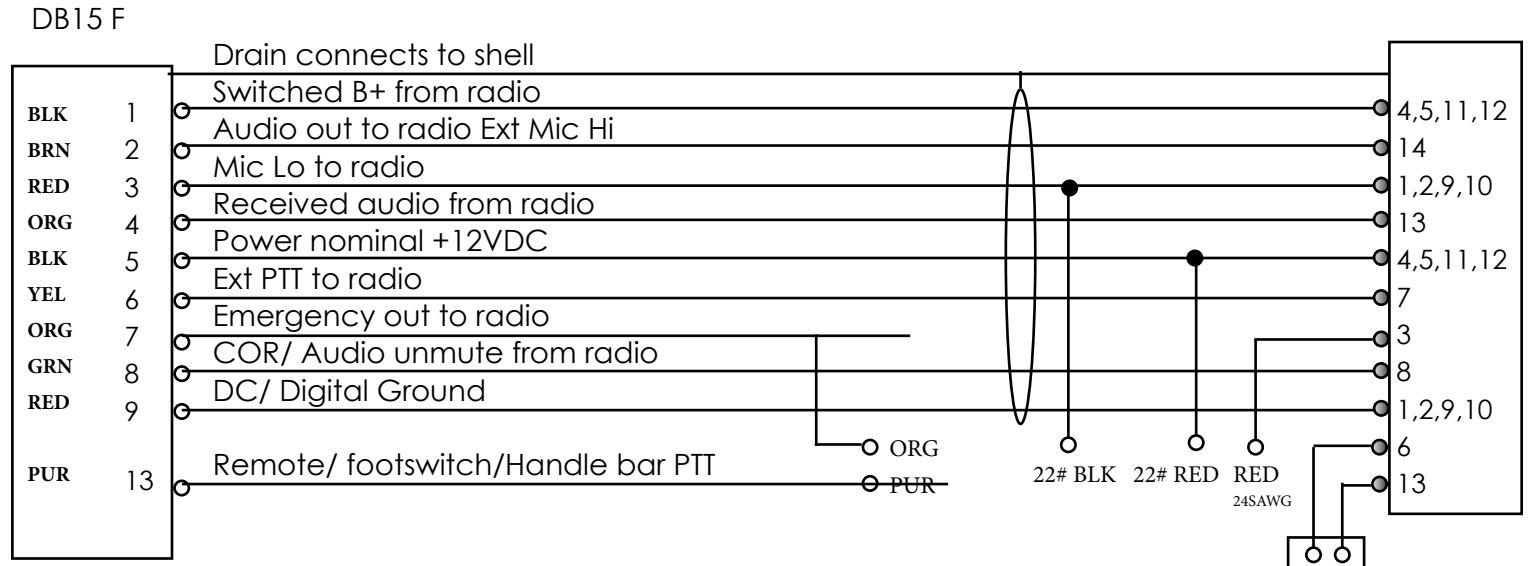

RED 24AWG -normally this is ignition sense input, but some SRM9000 models may be internally modified/jumpered to make this an emergency input. In such cases join RED to Orange.

BLU BLK (Spk socket)

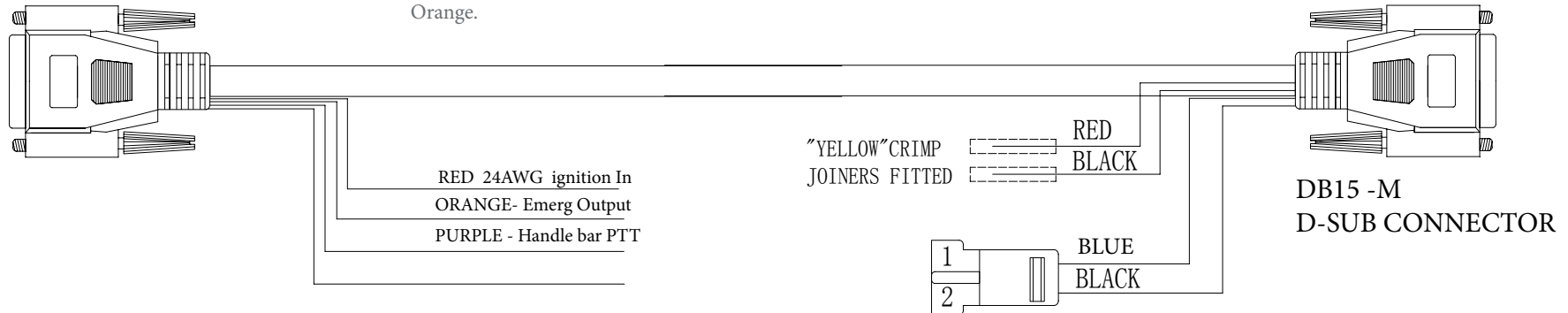

SRM9000 Programming info P 1/2



On User Interface window select "input/output"

Set DB15 -7 - Input, Function = PTT Ext,

Active = Low, Dbnce = 20

Set DB15 -8 - Output, Function = Valid signal

Active = Low

40mVRMS ext input

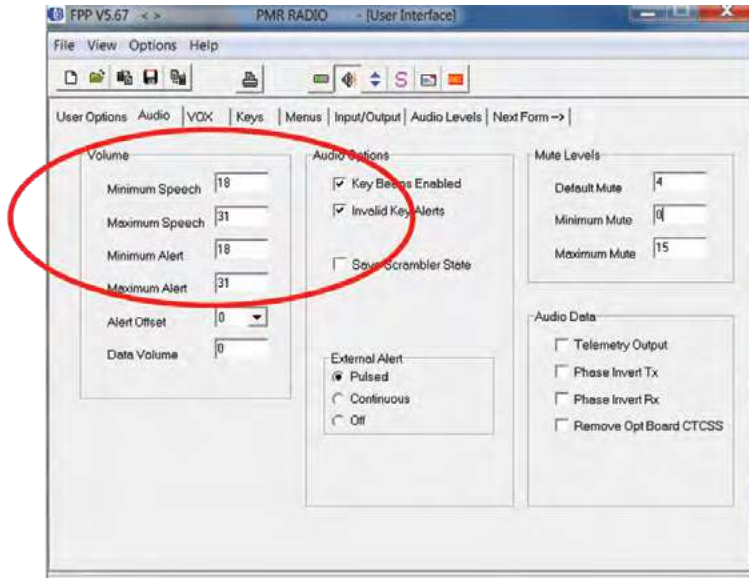

On User Interface select "audio levels"

Set Transmit input/External Input = 0

Set Transmit input/External Input (fine) = 0.0

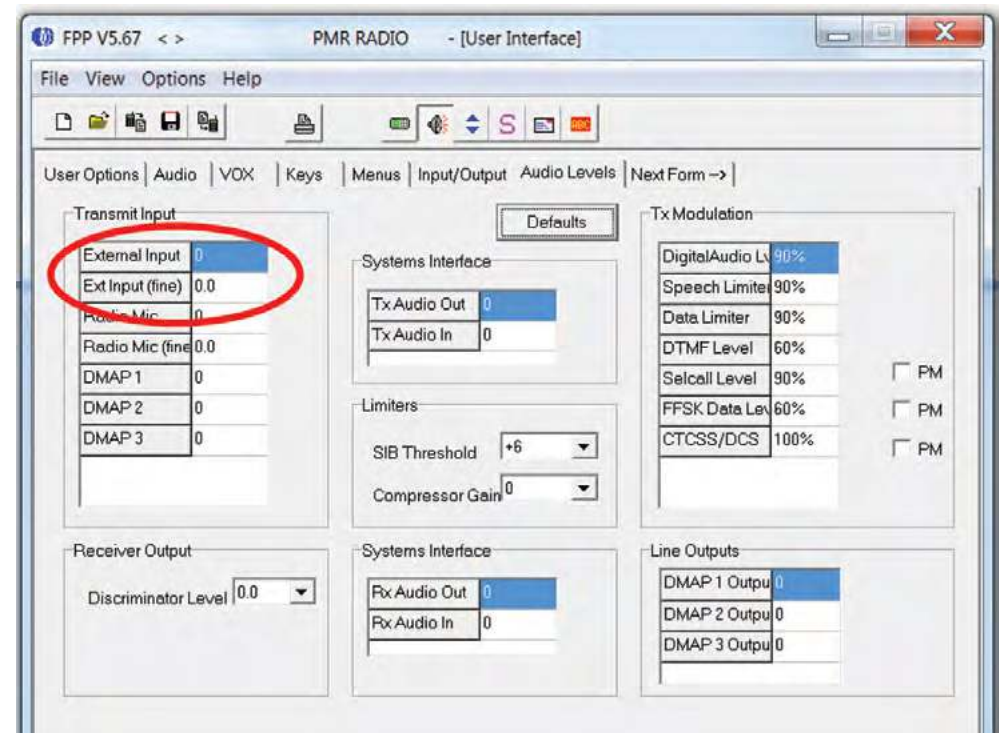

SRM9000 Programming info P 2/2

On User Interface choose "Audio"

Set Volume/Minimum speech = 18

Set Volume/Maximum speech = 31

Set Volume/Minimum alert = 18

Set Volume/Maximum alert = 31

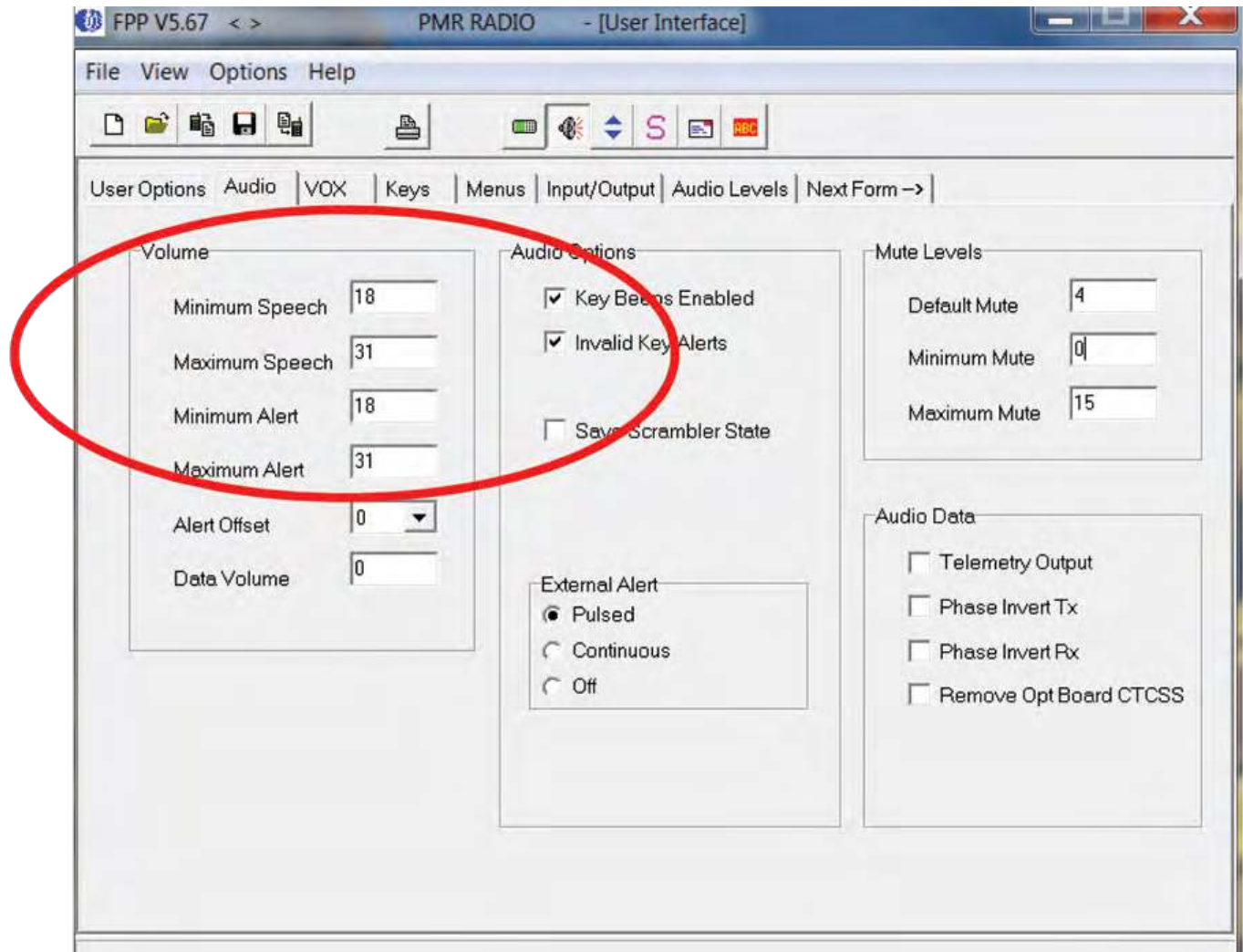

XCA-SRG Interface cable: (XMC-SRG & XCA-XMC)

for Sepura SRG TETRA series mobiles
(add X10DR to an existing SRG power cable)



Connects to XCA-XMC included adaptor

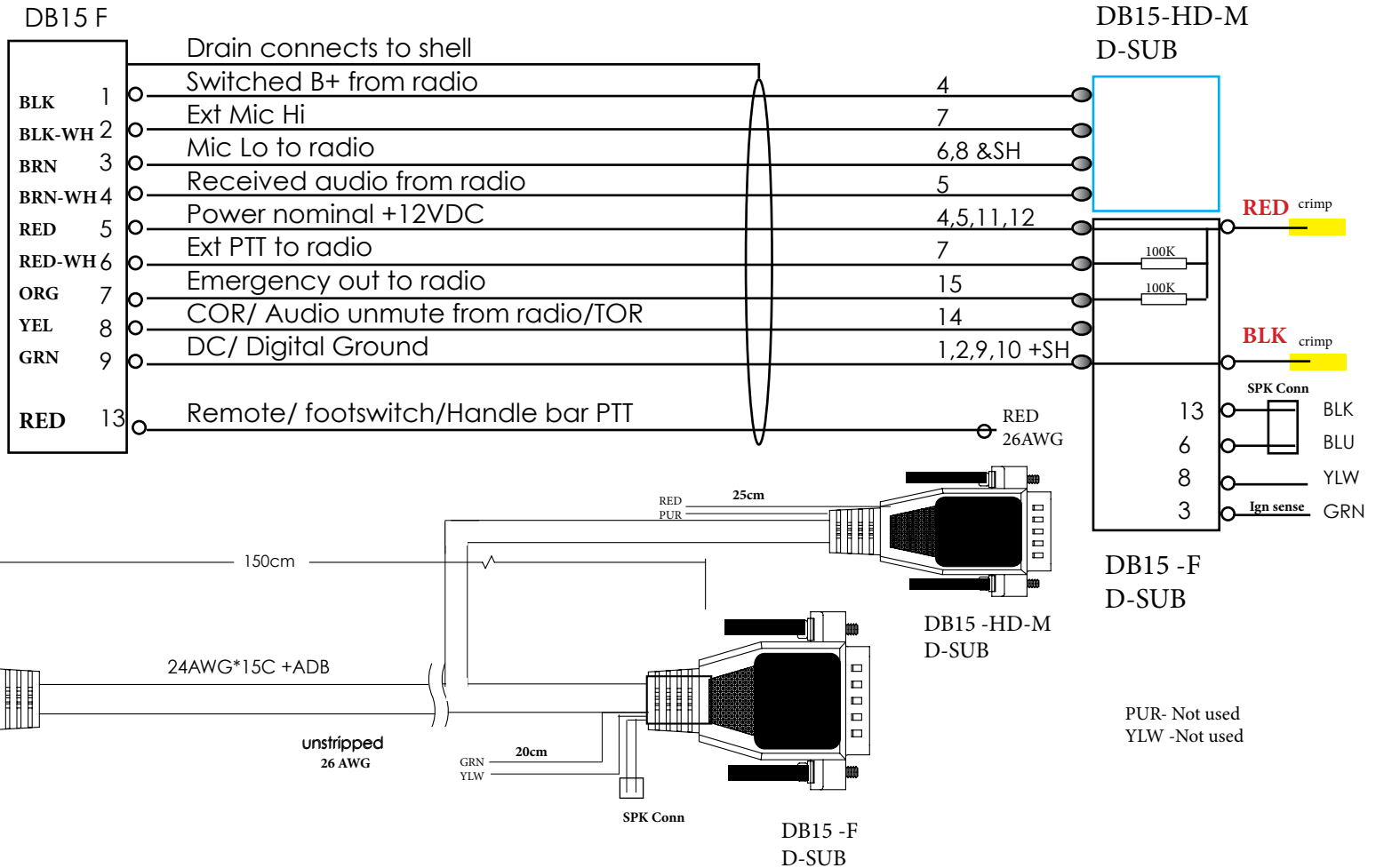

In Radio Manager create template “X10DR” and set audio presentation as follows:

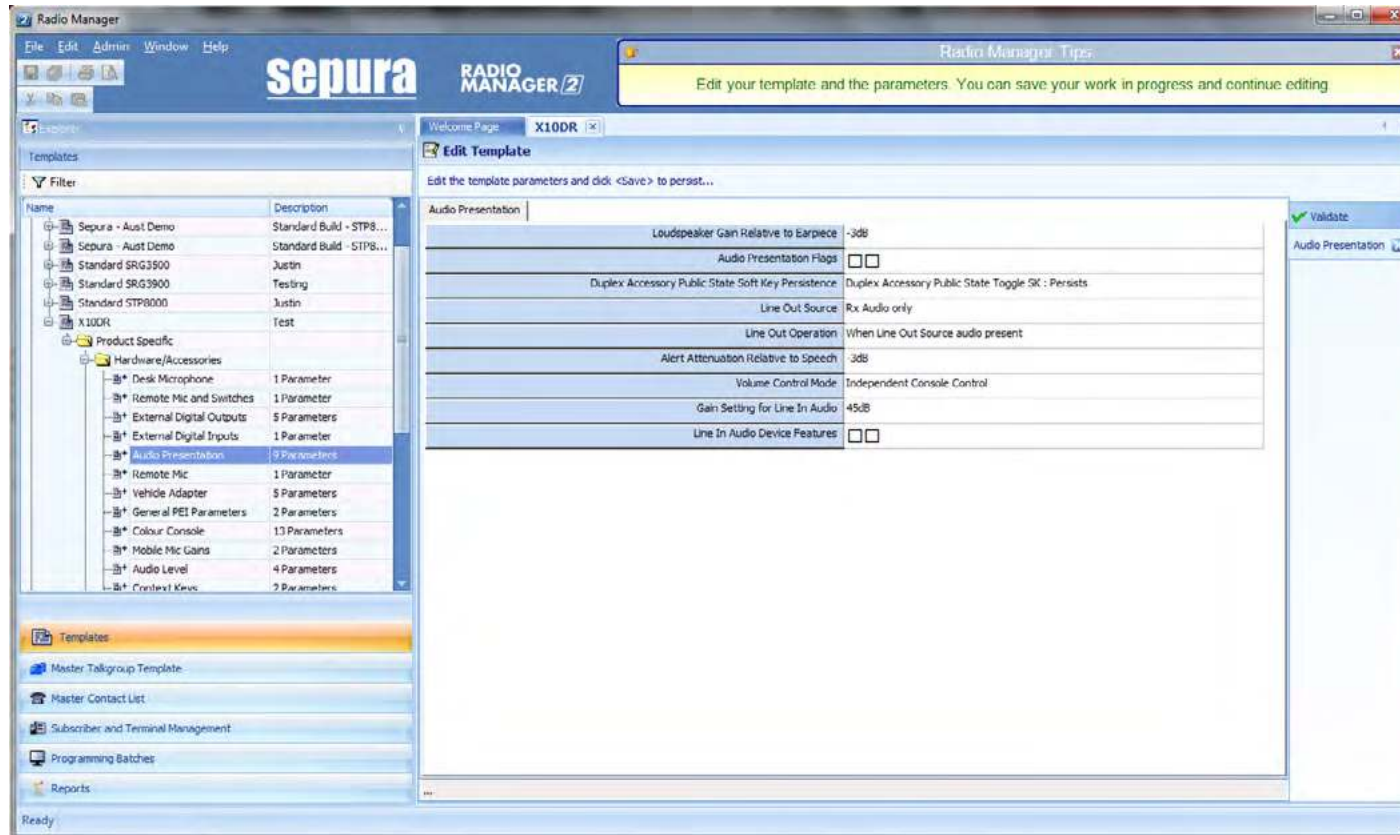

In Radio Manager template “X10DR” external digital inputs as follows:

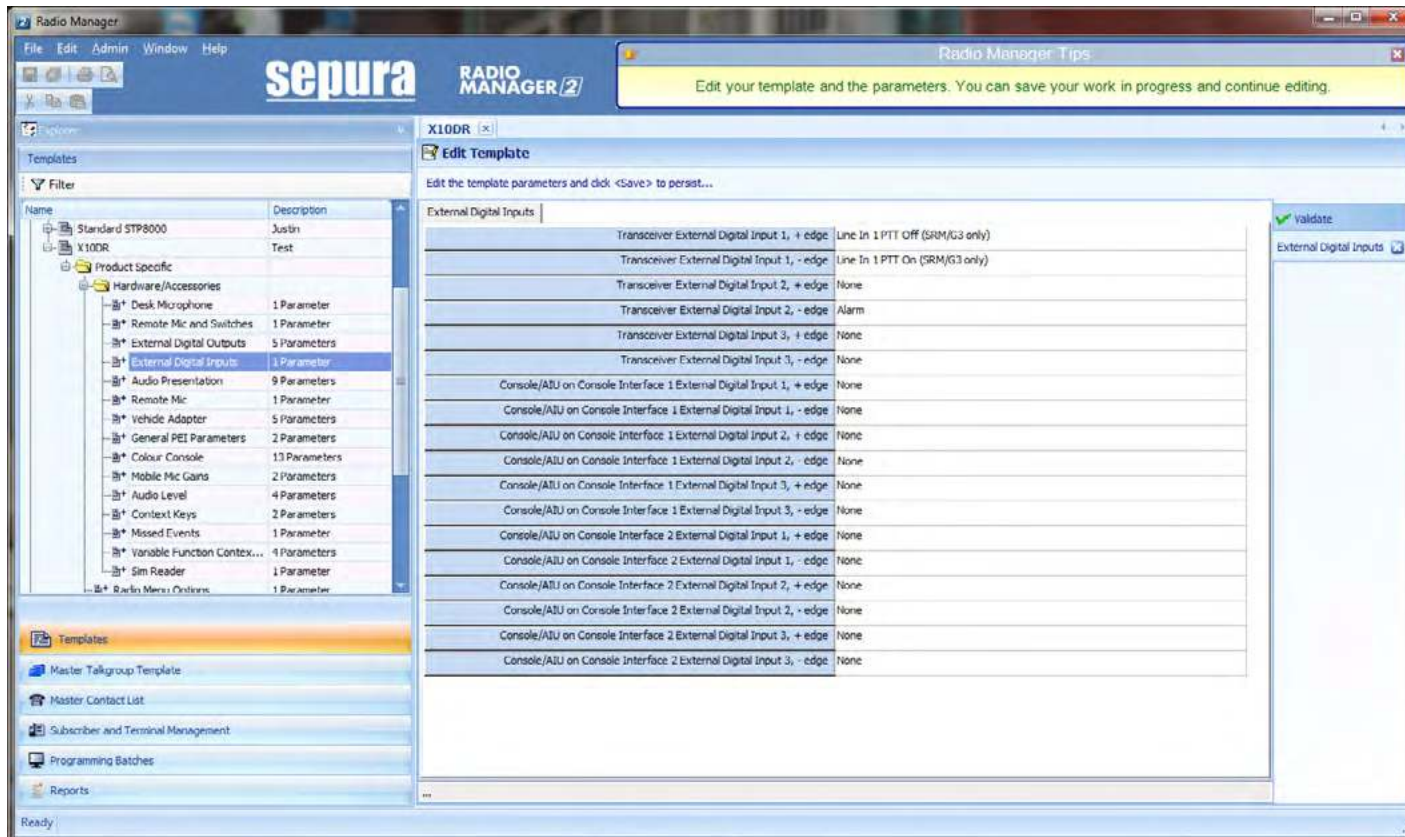

In Radio Manager create template “X10Dr” and set External digital outputs as follows:

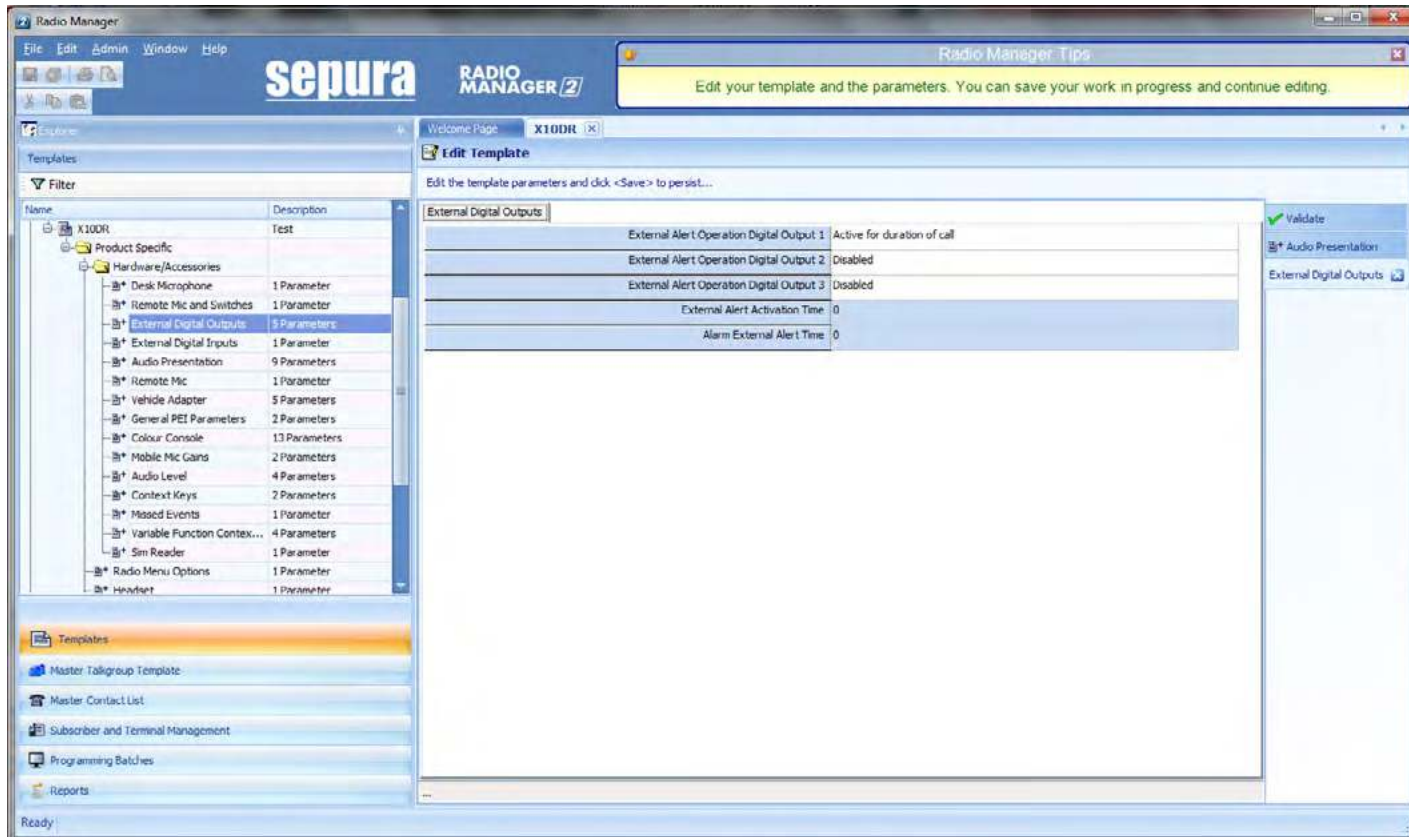

XCA-V15 Cable Adaptor: for Vertex 15 pin lower tier mobiles

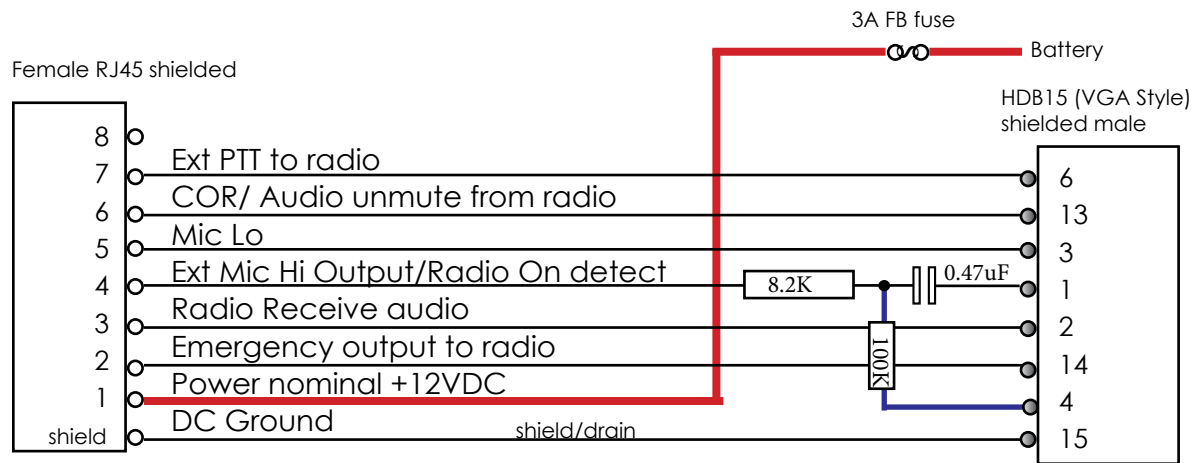

NOTES:

Radio Programming:
Pin 13 COR/Spk unmute
Pin 14 Emerg Input

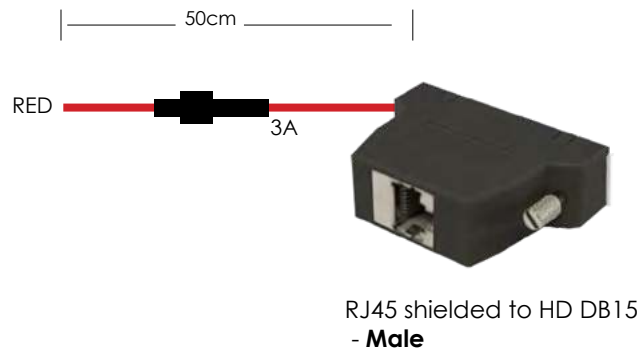

HDB 15P (VGA style)
D-Sub connector
-MALE



XCA-V25M Cable Adaptor: for Vertex VX5500 etc High tier mobiles

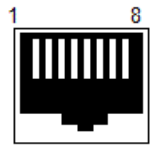
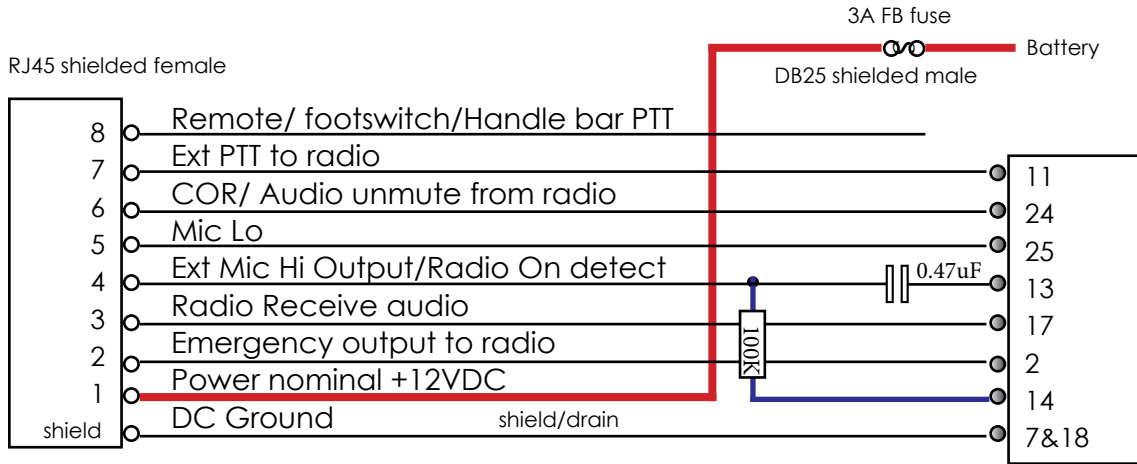

Front View

Receptacle

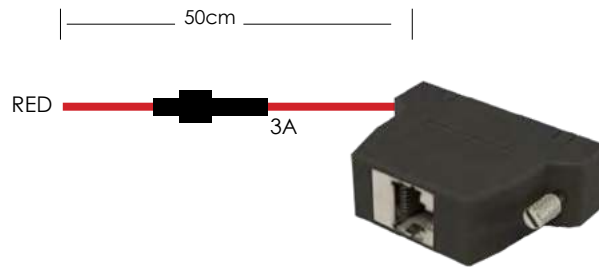

RJ45 shielded DB25
- Male

DB25P
D-Sub connecto-MALE



XCA-V25 Cable Adaptor: for Vertex VX5500 etc High tier mobiles

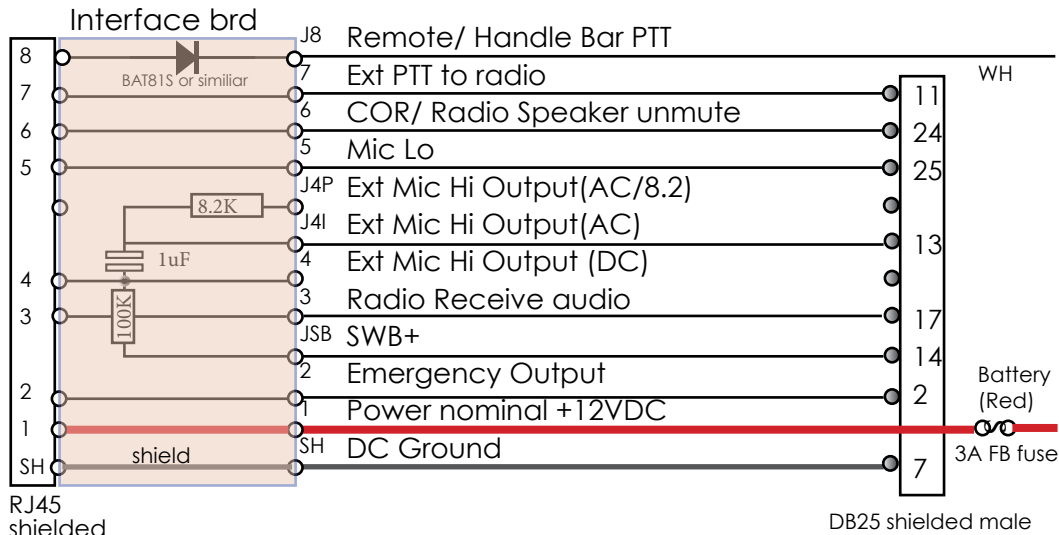

RJ45 shielded Female

DB25 shielded male

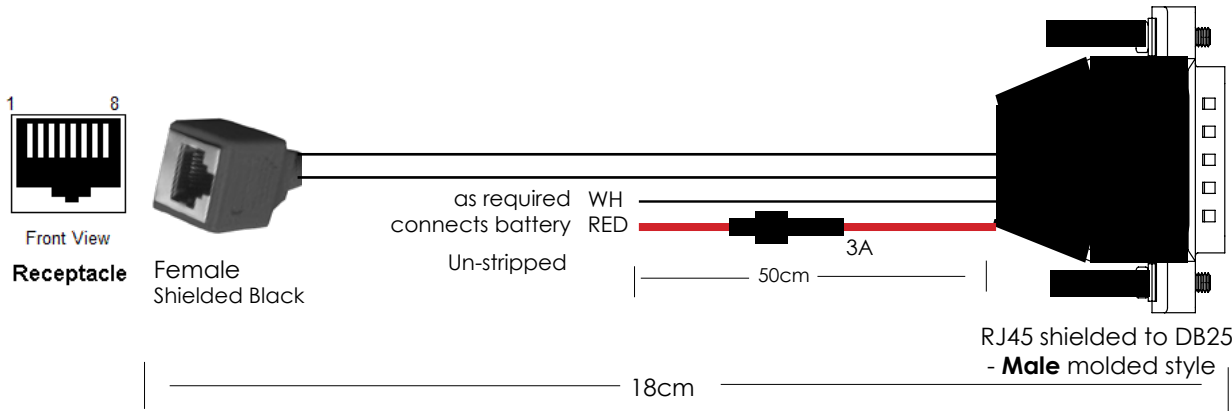

XCA-T15 Cable Adaptor: for TM8000/9000 series etc

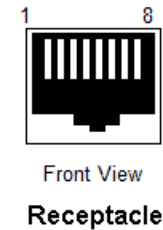
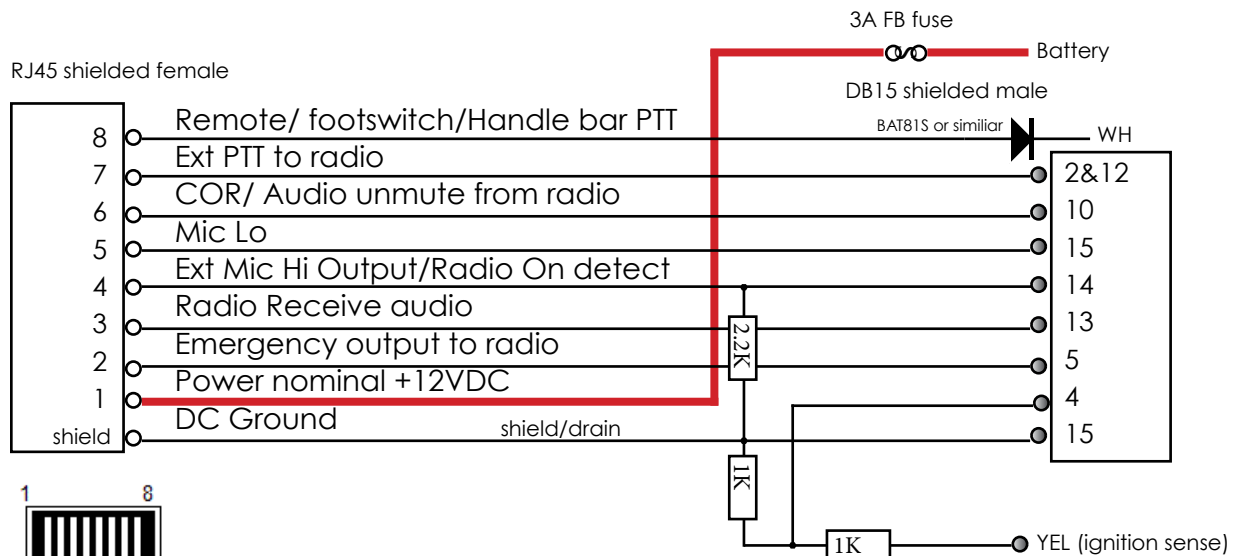

RJ45 shielded to DB15 - Male
molded style

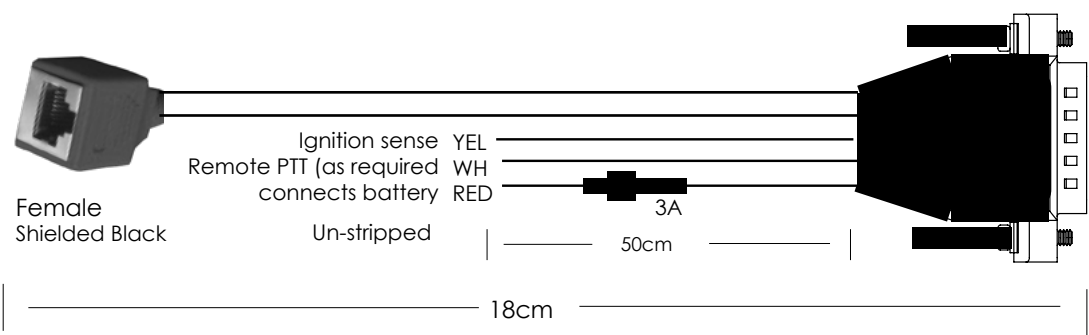

Notes:

- Program Radio connector
- 2- Send Mic to radio spk*
 - 4- ignition sense
 - 5 - Emerg in
 - 10 - Busy out
 - 12 - PTT in
 - 13 - Audio tap out
 - 14 - Audio Tap In
- * when radio permits



Select Programmable I/O window and select "Digital" then program as follows:

Programmable I/O

Digital | Audio | Channel Selection

Pin	Direction	Label	Action	Active	Debounce	Signal State	Mirrored To
AUX_GPI1	Input	PIN_12	External PTT 1	Low	10	None	None
AUX_GPI2	Input	PIN_5	Enter Emergency Mode	Low	10	None	None
AUX_GPI3	None	PIN_4	No Action	None	None	None	None
AUX_GPIO4	Output	PIN_10	Signaling Audio Mute Stati	Low	None	None	None
AUX_GPIO5	Input	PIN_2	Send Mic Audio To Spkr	Low	10	None	None
AUX_GPIO6	None	PIN_9	No Action	None	None	None	None
AUX_GPIO7	None	PIN_1	No Action	None	None	None	None
IOP_GPIO1	None	PIN_9	No Action	None	None	None	None
IOP_GPIO2	None	PIN_10	No Action	None	None	None	None
IOP_GPIO3	None	PIN_11	No Action	None	None	None	None
IOP_GPIO4	None	PIN_12	No Action	None	None	None	None
IOP_GPIO5	None	PIN_13	No Action	None	None	None	None
IOP_GPIO6	None	PIN_14	No Action	None	None	None	None
IOP_GPIO7	None	PIN_15	No Action	None	None	None	None
CH_GPIO1	None	C_HEAD	No Action	None	None	None	None

Select Programmable I/O window and select "Audio" then program as follows:

Programmable I/O

Digital | Audio | Channel Selection

	Rx/PTT Type	Tap In	Tap In Type	Tap In Unmute	Tap Out	Tap Out Type	Tap Out Unmute
	Rx	None	A - Bypass In	On PTT	R10	D - Split	Speaker Unmuted
	Mic PTT	None	A - Bypass In	On PTT	T3	D - Split	On PTT
	EPTT1	R10	A - Bypass In	On PTT	None	C - Bypass 0	On PTT
	EPTT2	None	A - Bypass In	On PTT	None	C - Bypass 0	On PTT

Select PTT set-up window and select “External PTT (1)” then program as follows:

PTT

Mic PTT | **External PTT (1)** | External PTT (2)

EPTT1 Call Initiation and Monitor

PTT Monitor

De-key After PTT Monitor

EPTT1 Inhibit

Inhibit PTT When Emergency Active

Inhibit PTT Transmission When Mic on Hook

Inhibit PTT When External PTT Inhibit Active

Indicate PTT Inhibit to User

Advanced EPTT1

PTT Transmission Type ←

PTT State is Reflected

PTT Priority

Audio Source ←

XCA-T15D Cable Adaptor: for TM9300 DMR series

NOTE: (Some recent TM9300 production units have reportedly exhibited less background TDMA "ground noise" when using original XCA-T15 cable adaptors. If unsure trial both versions prior to purchasing large quantities of XCA-T15/D adaptors)

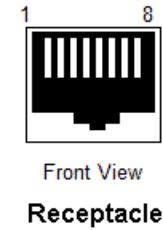
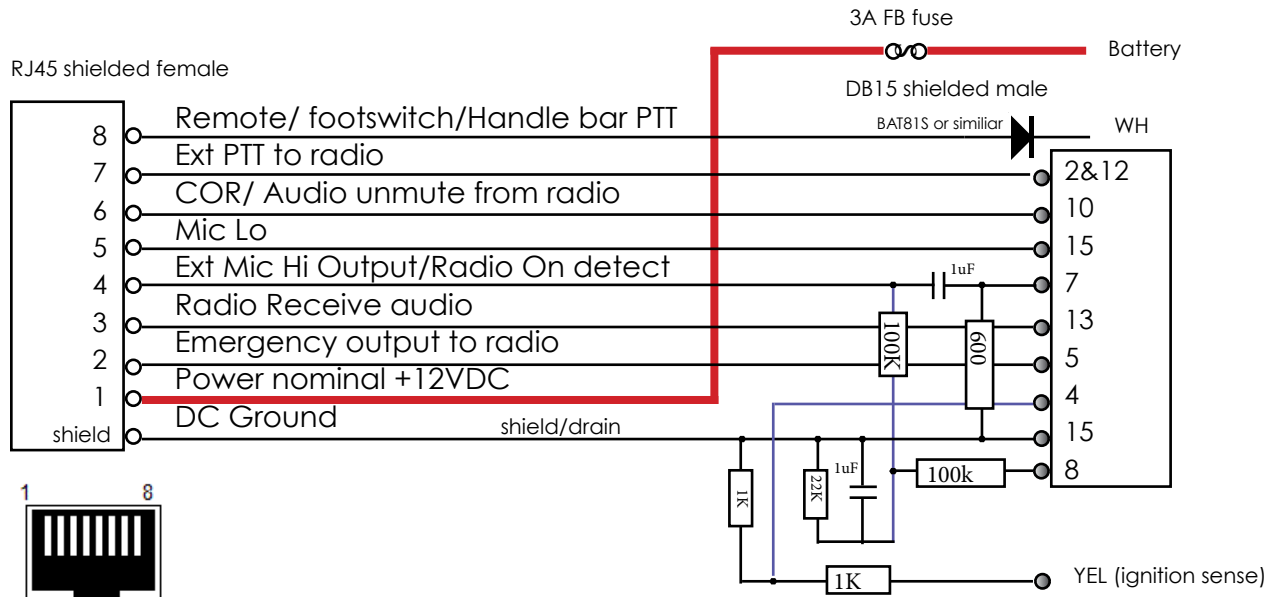

RJ45 shielded to DB15 - Male
molded style

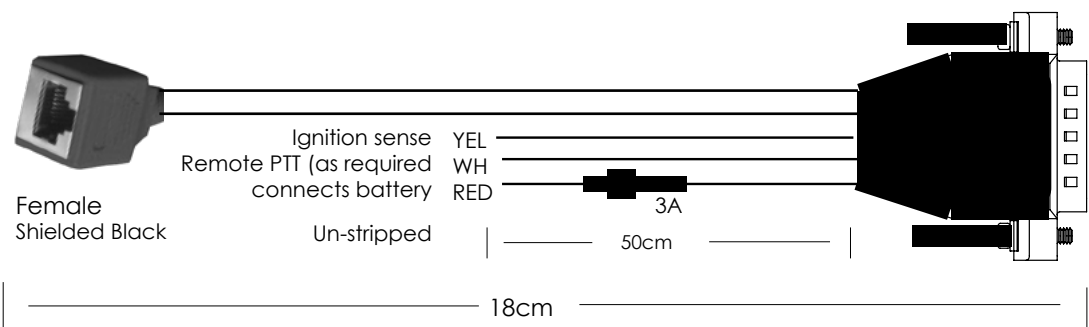

- Notes:
Program Radio connector
- 2- Send Mic to radio spk*
 - 4- ignition sense
 - 5 - Emerg in
 - 7 - Audio Tap In (T3)
 - 10 - Busy out
 - 12 - PTT in
 - 13 - Audio tap out

* when radio permits
Use gateway tuner to increase gateway audio output to +12dBm



XCA-T15A Cable Adaptor: for TM8000/9000 series etc **WITH emerg on pin 1** (pre 11/2017)

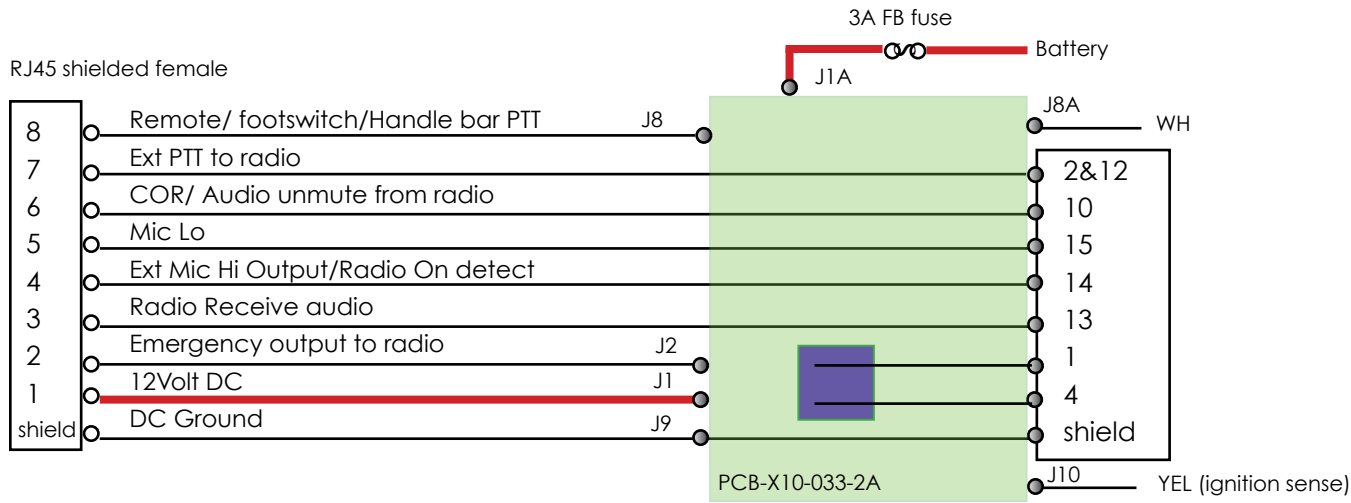

Notes:

- Program Radio connector
- 2- Send Mic to radio spk*
 - 4- ignition sense
 - 1 - Emerg in
 - 10 - Busy out
 - 12 - PTT in
 - 13 - Audio tap out
 - 14 - Audio Tap In

* when radio permits

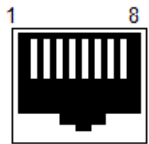

Front View

Receptacle

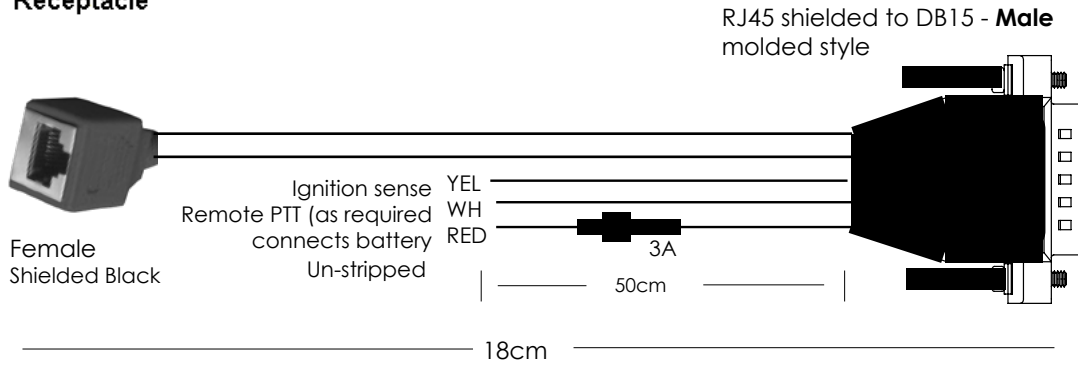

XCA-H26 Interface cable:

for Hytera MD68x Tetra & 78x DMR mobiles

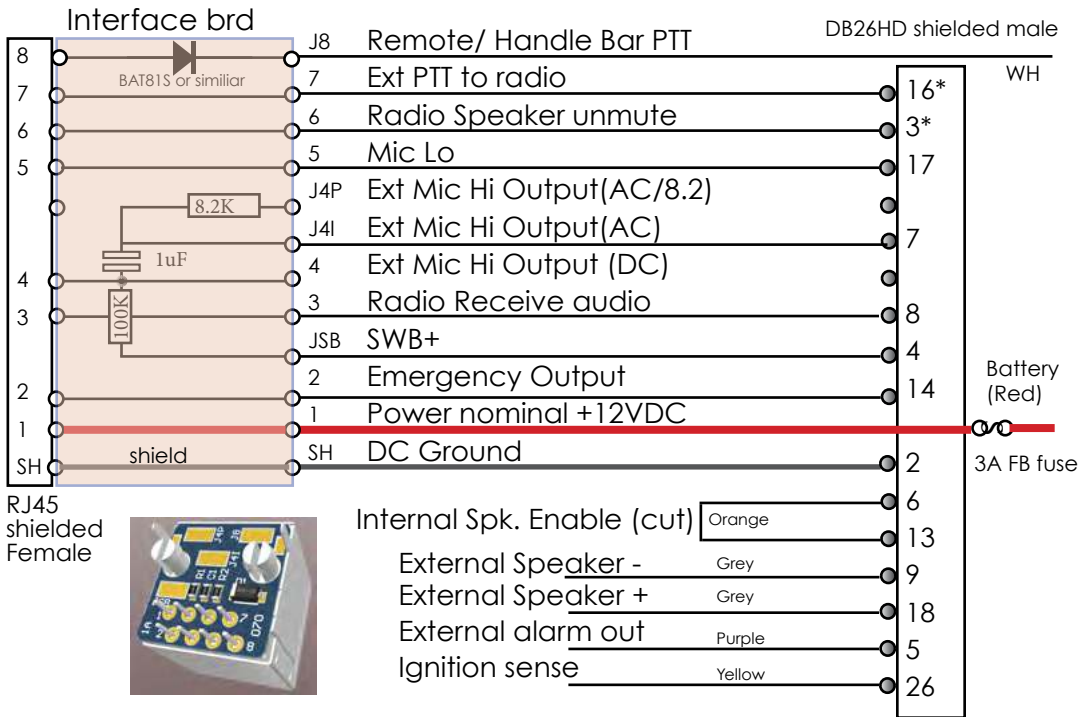

Notes:

***Program Radio connector**

Pin 3: Spk Active Indicate - Active Low
Pin 16 Ext PTT - Active Low

RJ45 shielded Female

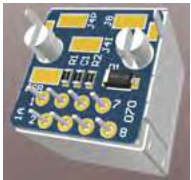
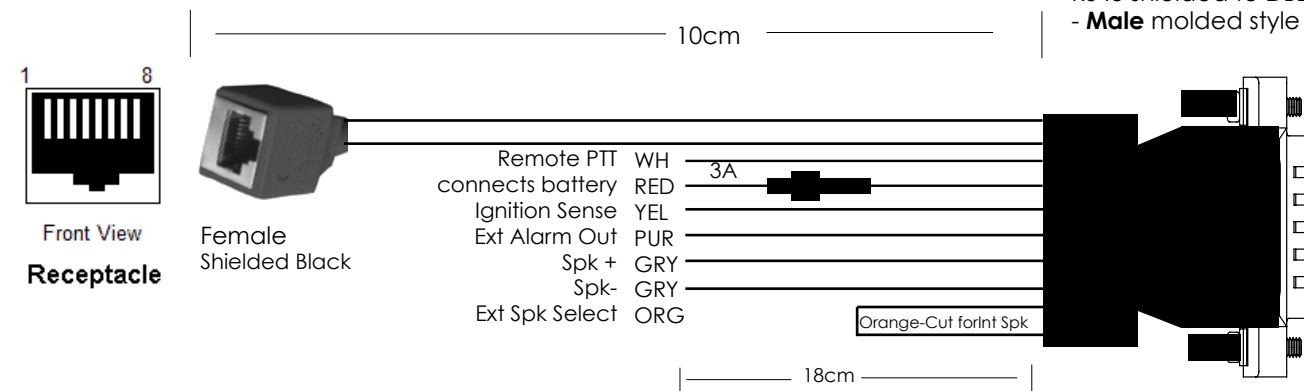

PHOTO: TO BE UPDATED



RJ45 shielded to DB26 HD - Male molded style



Hytera MD68/78 Programming info P 1/1



In CPS under "Accessories" set as follows:

Pin 3 select : Speaker Unmute detect
Set for : Low

Pin 16 select : Ext. Mic PTT
Set for : Low

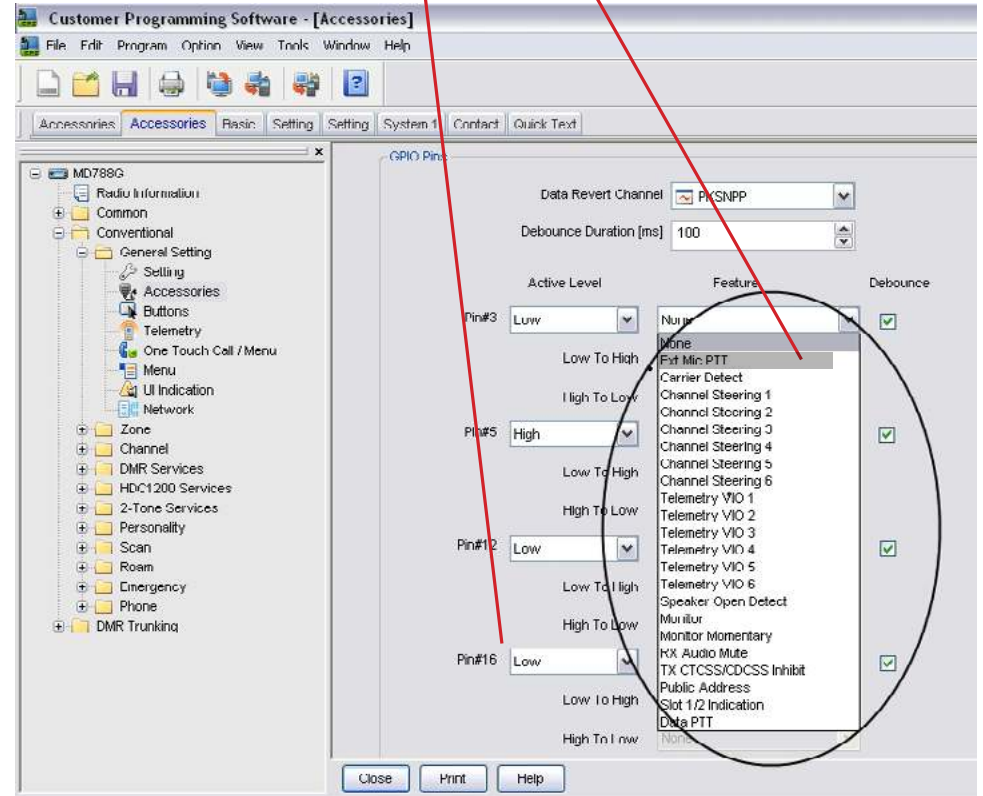
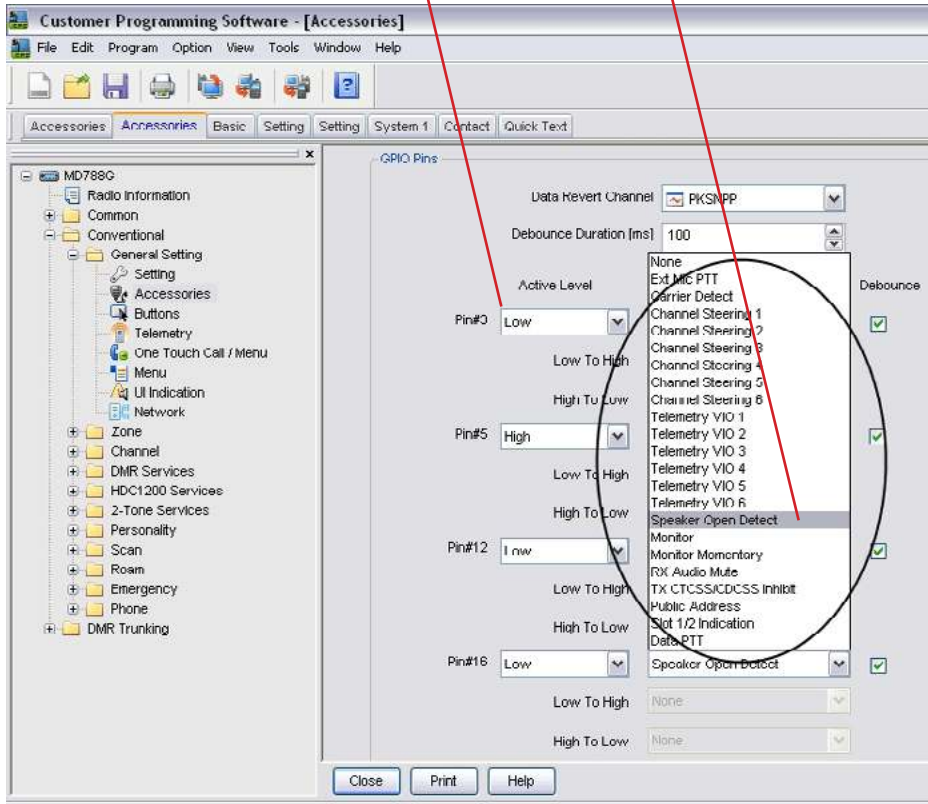

Edit - Conventional - General Setting - Accessories - GPIO Pins - Pin#16

XCA-R25 Interface cable: for Relm/Bendix King P25 mobiles



Notes:
Program radio Pin 23 for "cor".(radio speaker unmute)
Radio Emergency input is open circuit trigger (active high)

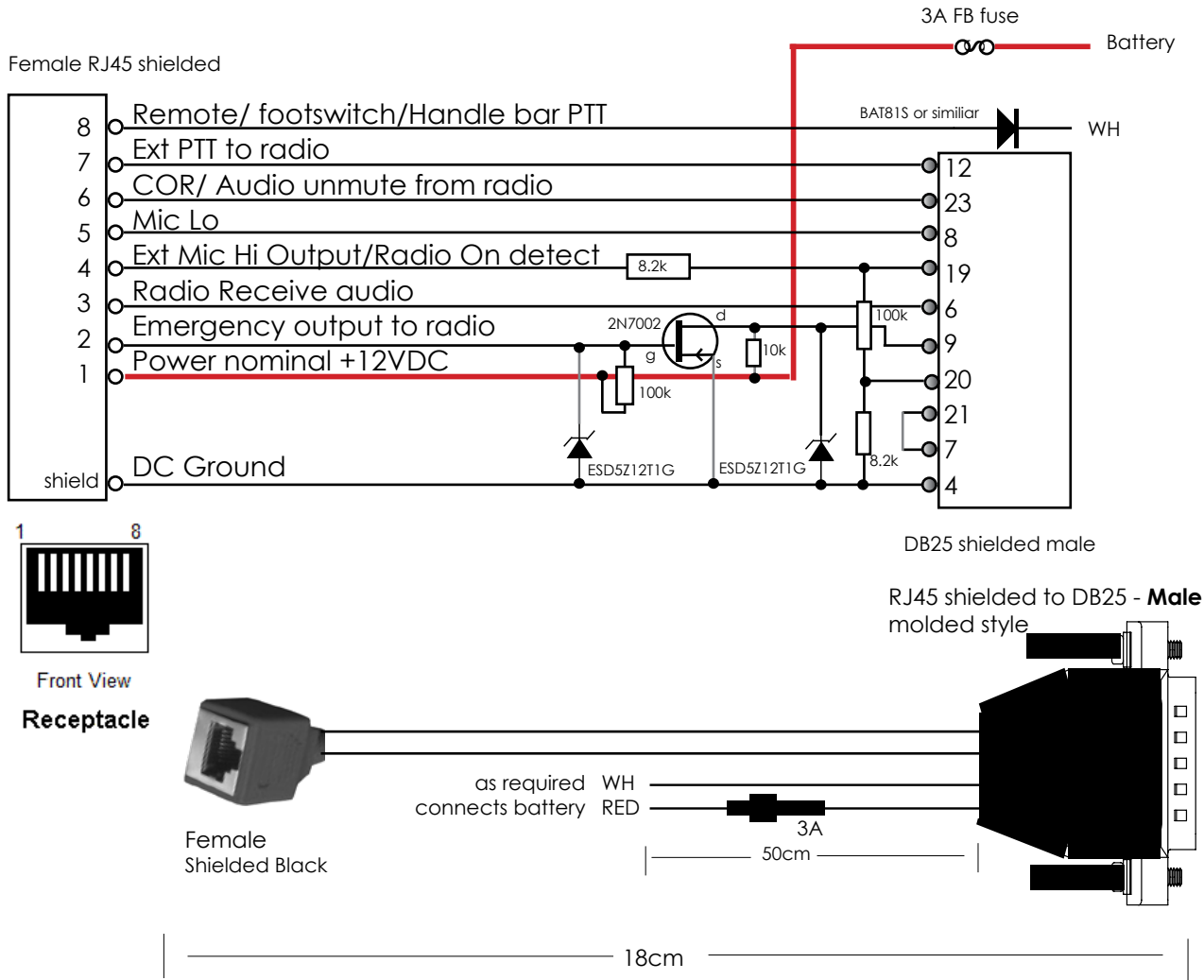

XCA-R15 Interface cable: for Relm/Bendix King P25 mobiles



Notes:
Program radio Pin 1 for Emergency.

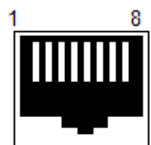
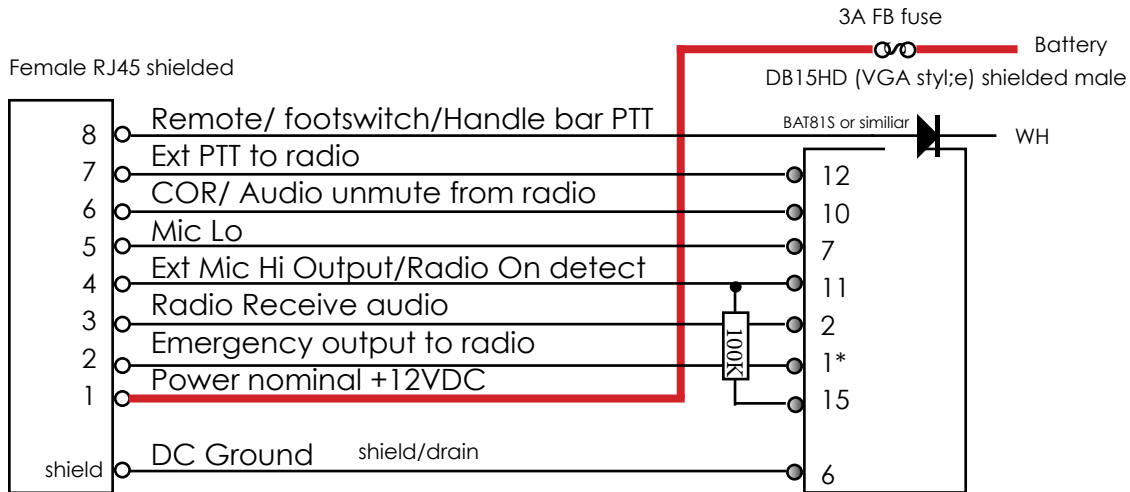

Front View

Receptacle

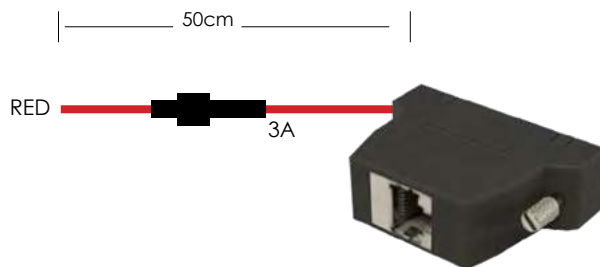

RJ45 shielded to HD DB15
- **Male**



XCA-T26 Interface cable:

for Teltronic MDT400 mobiles



*Requires pressing (phonebook) + (9)
 + (7) then setting audio accessory to
 Handsfree kit
 **Requires programming input 2
 ***Requires programming

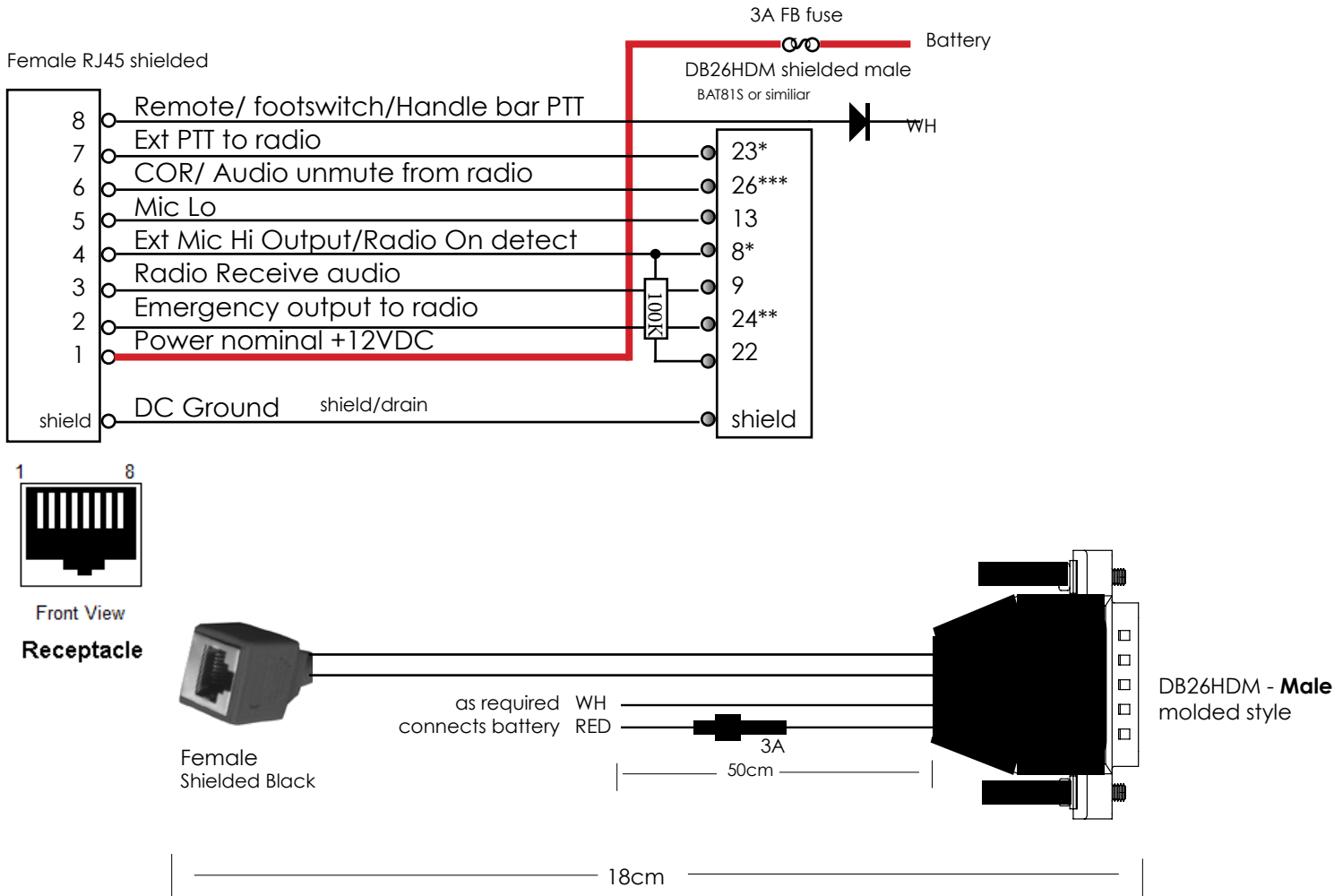

XCA-C26 Interface cable:

for Airbus /Cassidian mobiles TMR880/i

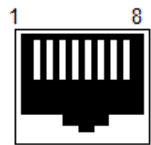
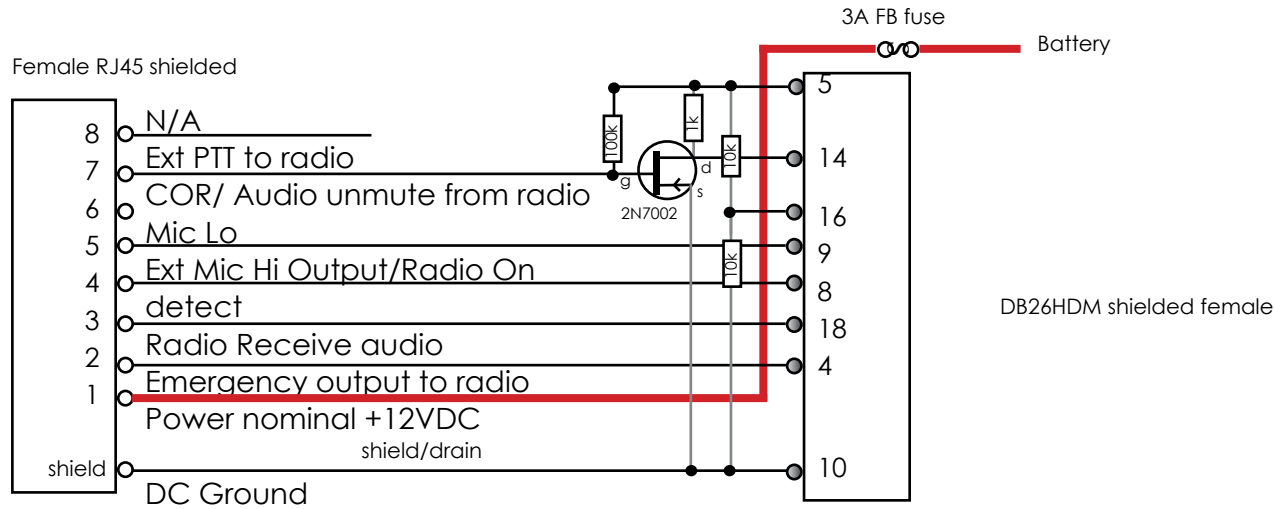

Front View

Receptacle

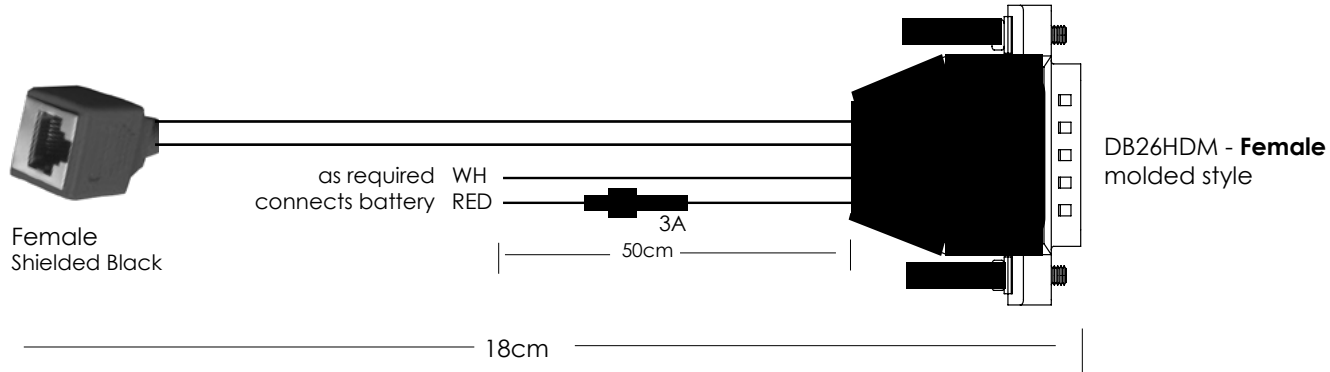

XCA-HXG Interface cable:

for Harris XG100/ M7200/7300 High tier mobiles



Notes:
 Use RPM to select I/O and function required.

Program Radio DB44 connector
 2 - program for COR
 18 - program for PTT
 25 - program for Emerg

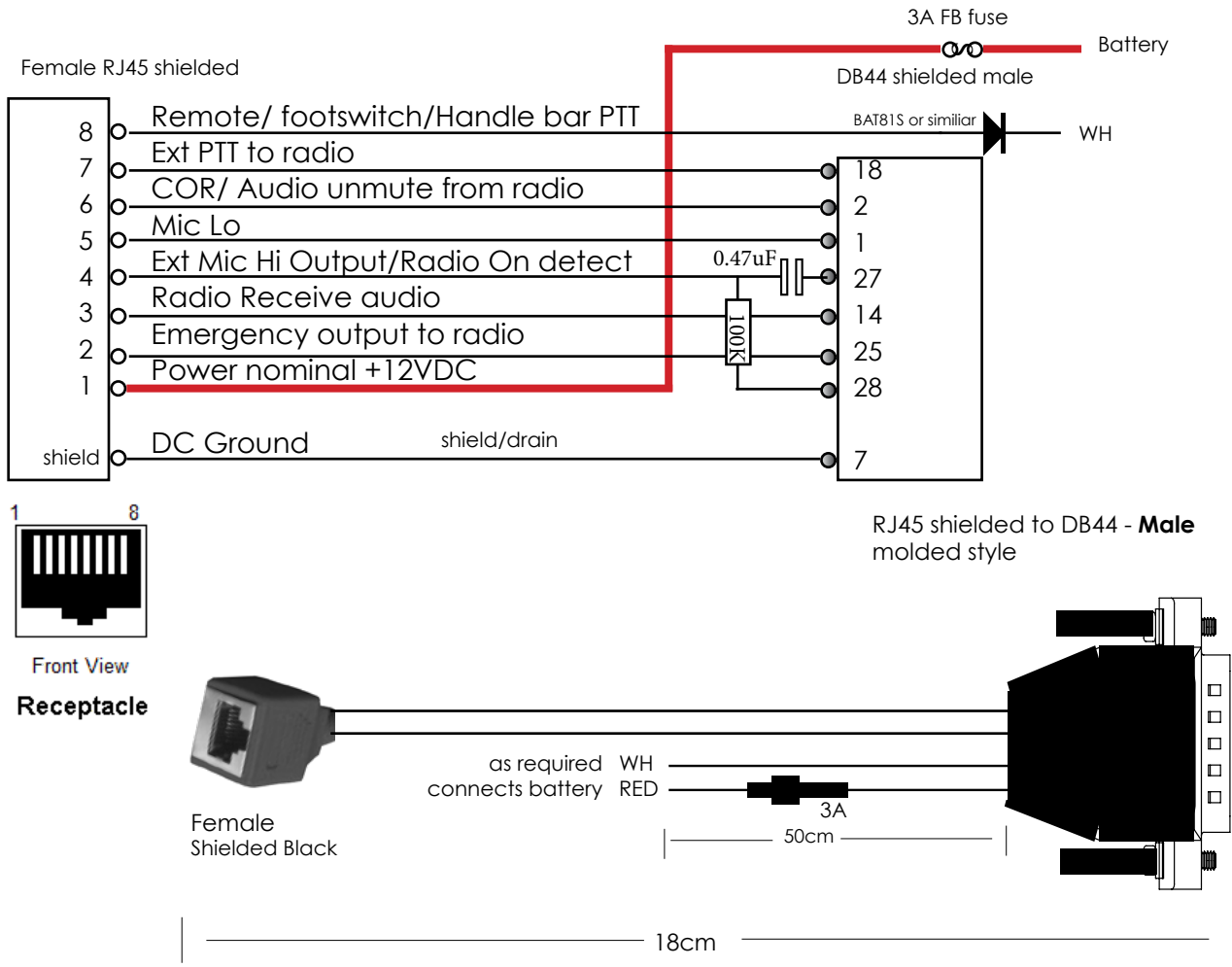

XCA-H37 Interface cable: for Harris M7100 mobiles



Notes:
Use RPM to select I/O and function required.

Program Radio connector
21 - program for PTT
23 - program for Emerg
22 - program for COR

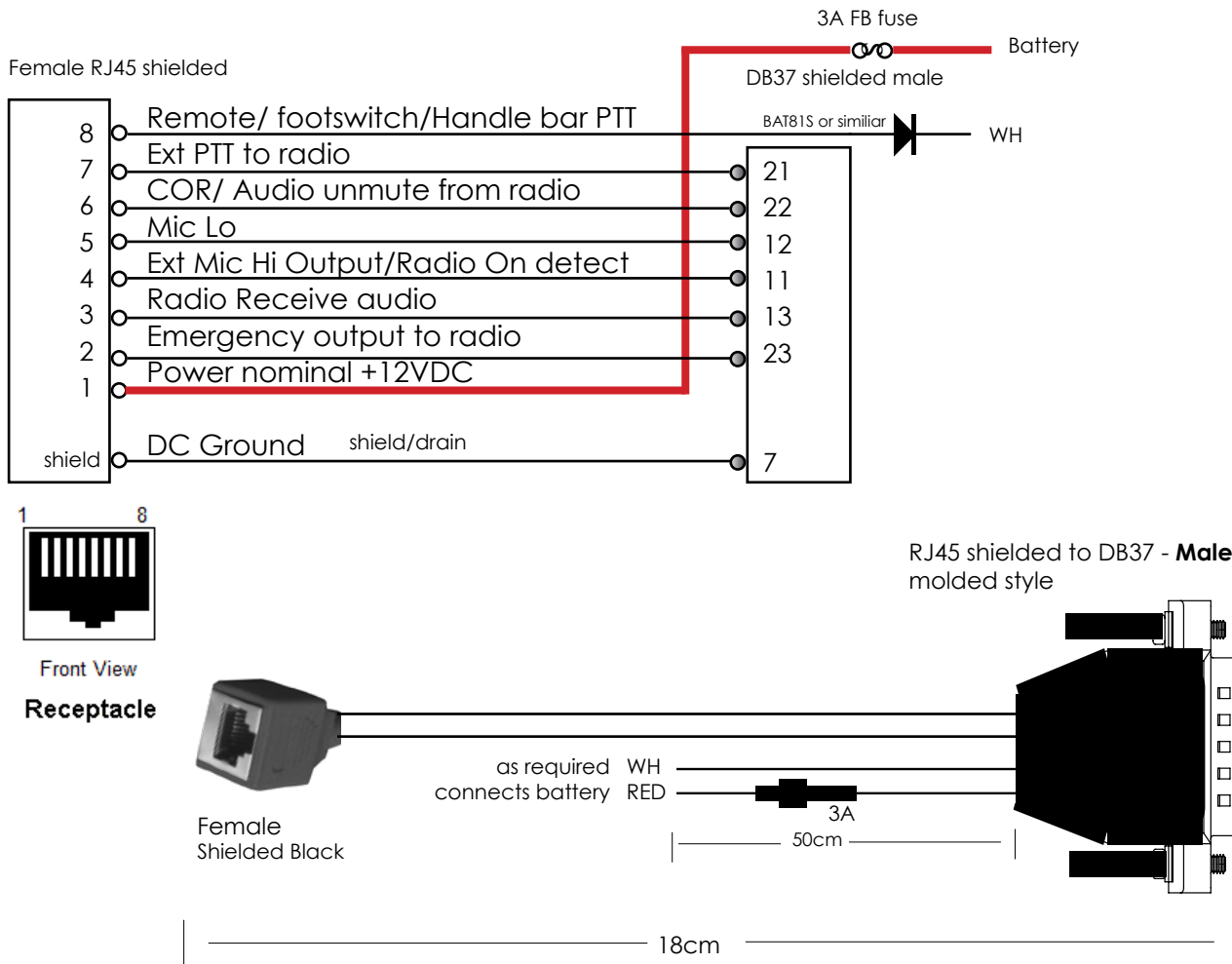

XCA-X44 Interface cable:

for Harris XL-185M, XL-200M High tier mobiles

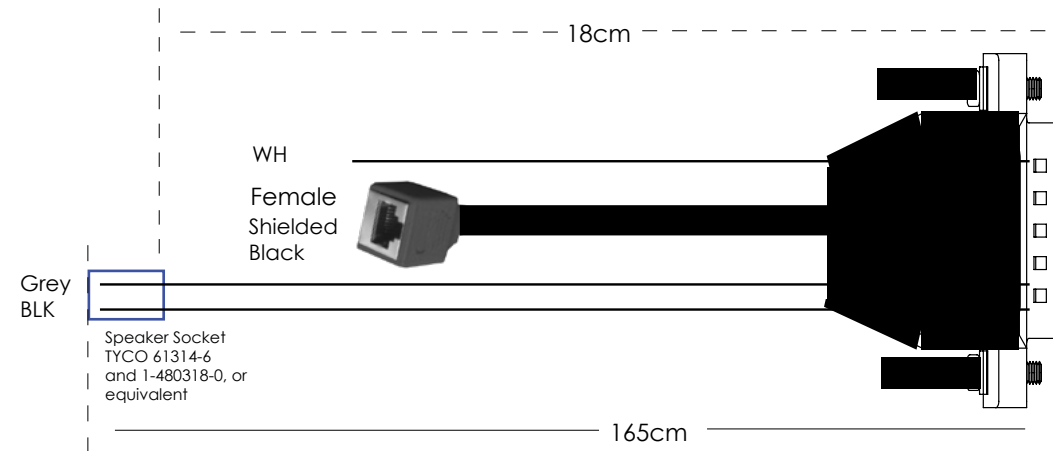
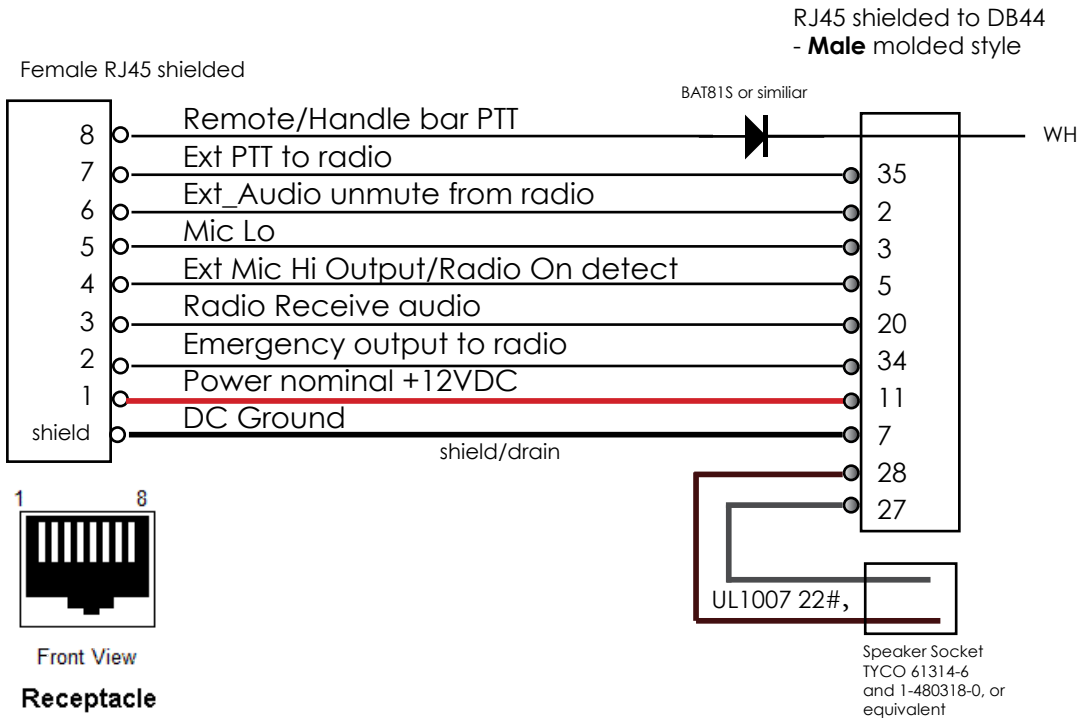

Notes:
Use RPM Radio Programmer to assign I/O functions:

Program Radio Connector
2 - program for Ext_Unmute (Active Lo)
35 - program for Ext_PTT
34 - program for Emergency

Gateway Audio Level Adjustment
Set Gateway Audio Out to "18"

VOX sensitivity
Set VOX sensitivity for "60"

X10DR®

LIBERATE YOUR MOBILE RADIO

Model

Elite

Pro



- LOAD FILE
- SAVE FILE
- DEFAULTS
- EXIT

- READ DEVICE
- PROGRAM DEVICE**
- RESTART DEVICE

GW: V2.11 Elite



Copyright WCL 2020

Date: Sept 30 2020 Revision: 3

XCA-H25 Interface cable:

for Harris M5300/7300 mobiles

for use with Option Cable CA-012349-001



Notes:

Use RPM to select I/O and function required.

Program Radio DB44 connector
 2 - program for COR
 18 - program for PTT
 25 - program for Emerg

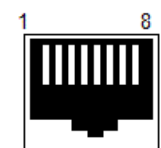
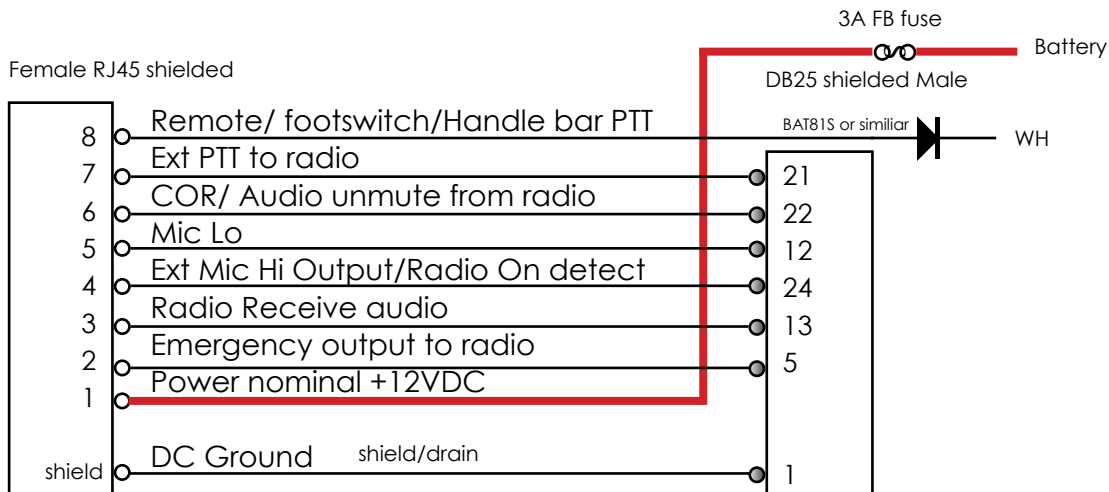

Front View
Receptacle

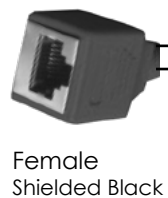

RJ45 shielded to DB25 - Male
molded style

as required WH
connects battery RED

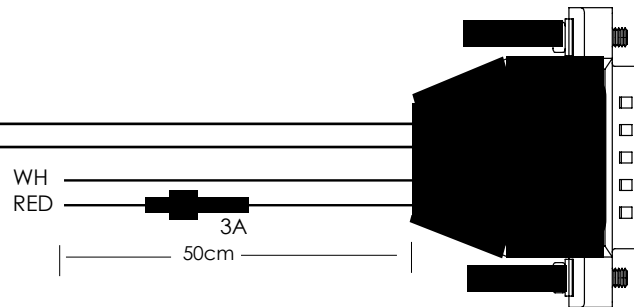

18cm



XCA-X25 Interface cable:

for Harris XL-185M, XL-200M High tier mobiles

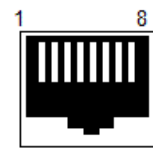
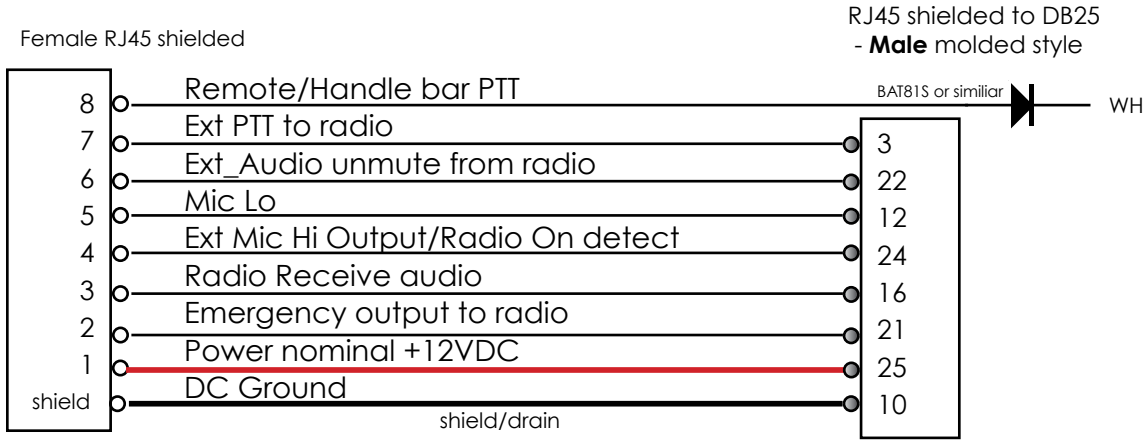

Front View

Receptacle

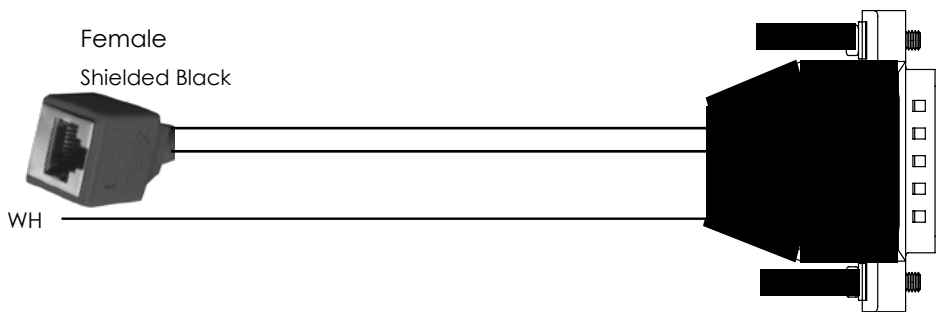

18cm



Notes:
Use RPM Radio Programmer to assign I/O functions.

Program Radio Connector
 2 - program for Ext_Unmute (Active Lo)
 35 - program for Ext_PTT
 34 - program for Emergency

Gateway Audio Level Adjustment
 Set Gateway Audio Out to "18"

VOX sensitivity
 Set VOX sensitivity for "60"



Model

Elite

Pro

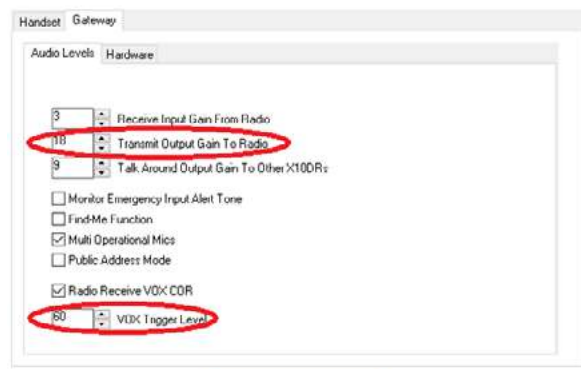

- LOAD FILE
- SAVE FILE
- DEFAULTS
- EXIT

- READ DEVICE
- PROGRAM DEVICE
- RESTART DEVICE

GW: V2.11 E06



Copyright WCL 2020

Date: Sept 30 2020 Revision: 2

XCA-EXP Interface cable:

for Cobham Explorer PTT satellite mobile DB15
Rev 1

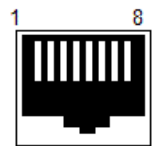
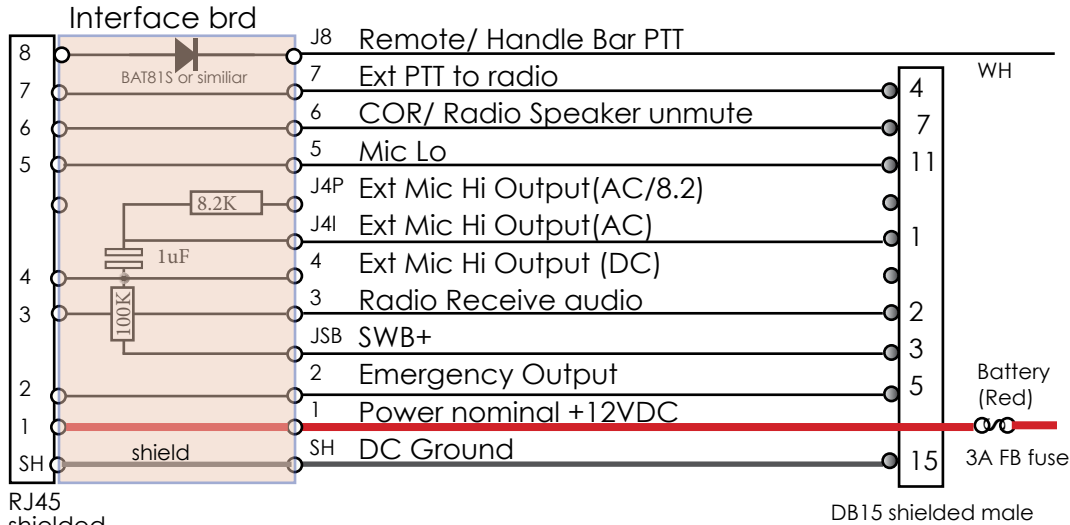

Front View

Receptacle



Female Shielded Black

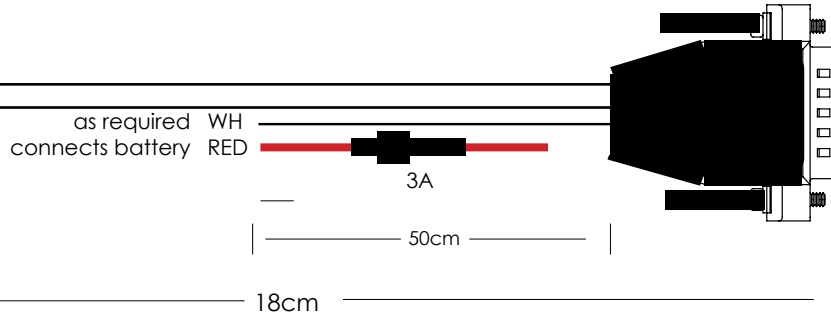

XCA-XMC Interface Adaptor:

Connects X10DR 2nd Gen gateways to X10DR1 XMC cables



Male RJ45 shielded

Male DB15

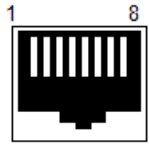
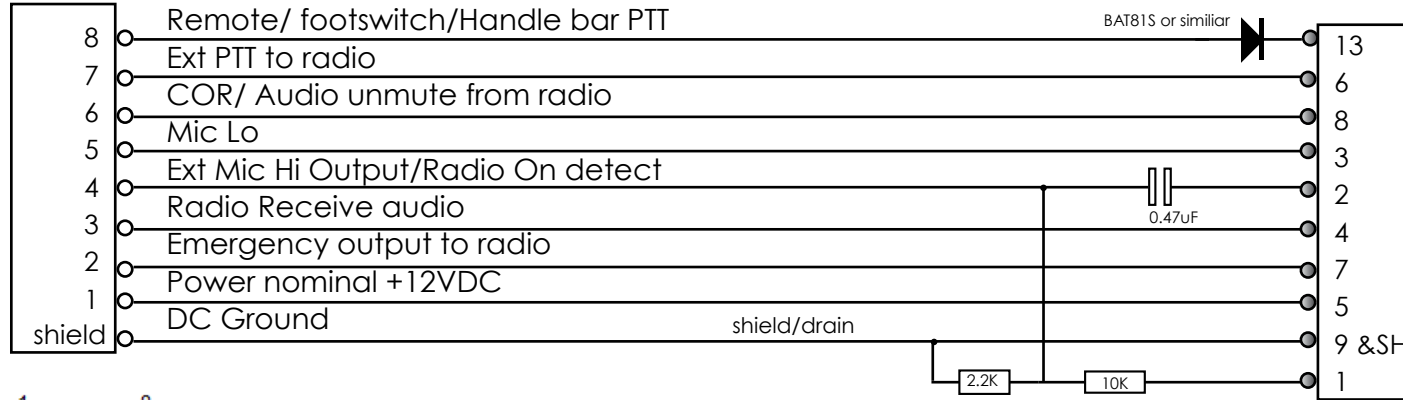

Front View
Receptacle

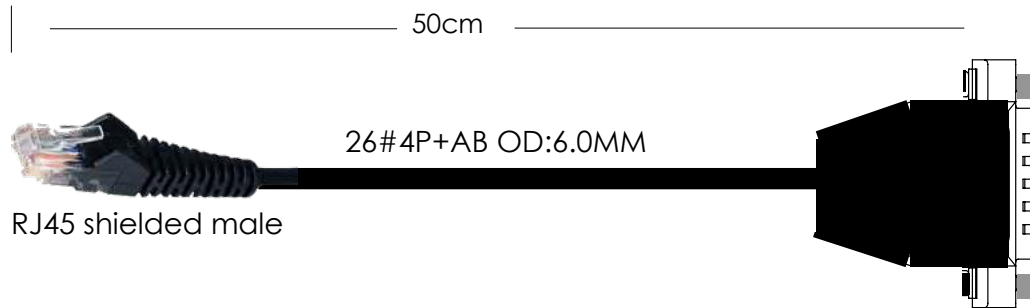

DB15 Receptacle
- **Male**- Molded

XMC-RJ45 Interface Adaptor:

Connects X10DR 2nd Gen XCA cables
to X10DR Lite & X10DR1 X-Ponders



Female RJ45 shielded

Female DB15 plug

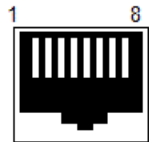
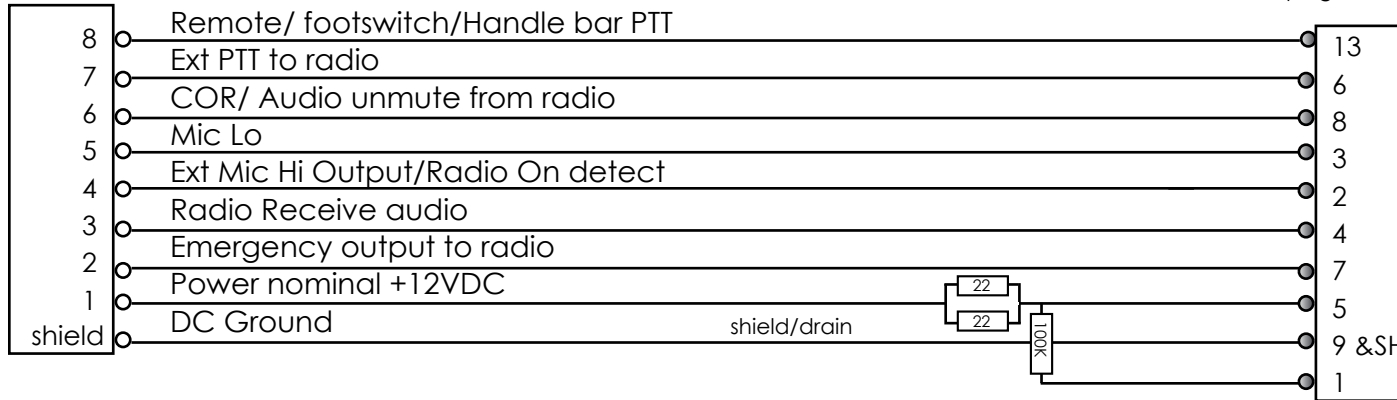

Front View

Receptacle

DB15 Plug
- Female



XCA-RJ Cable Adaptor: for PTT and Emergency buffered output

Male RJ45 shielded

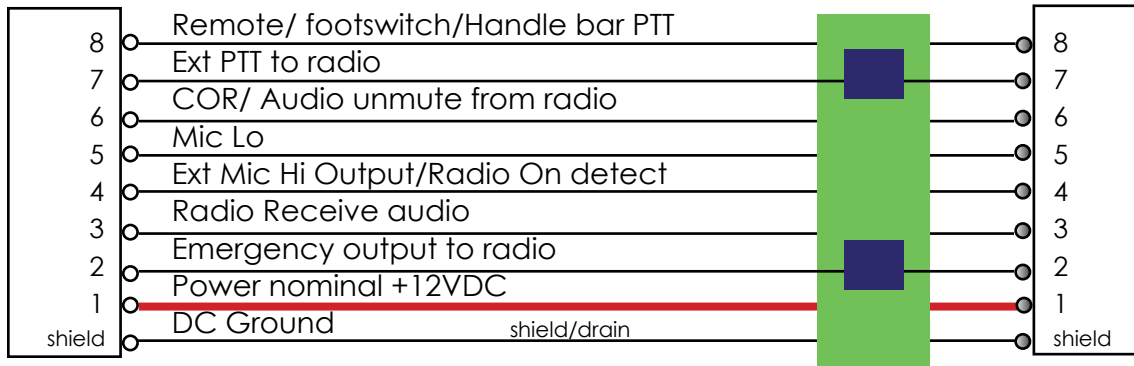

Connect via XDIA or XJB etc junction boxes

Can sink 100mA DC current

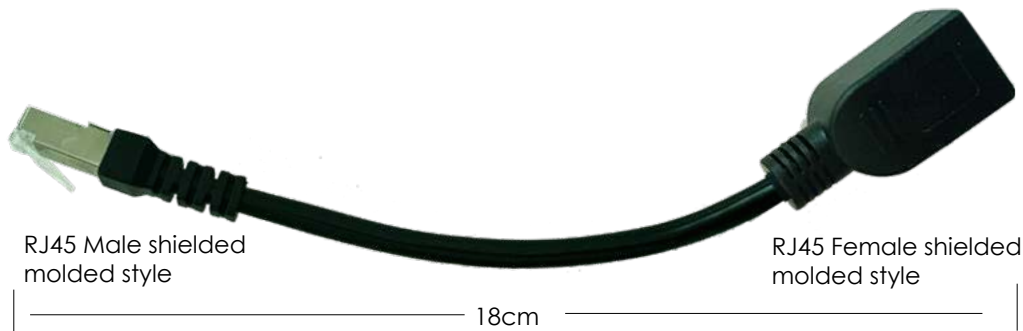

RJ45 Male shielded molded style

RJ45 Female shielded molded style

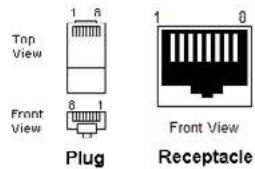

FOR INFORMATION – PCB SCHEMATIC:

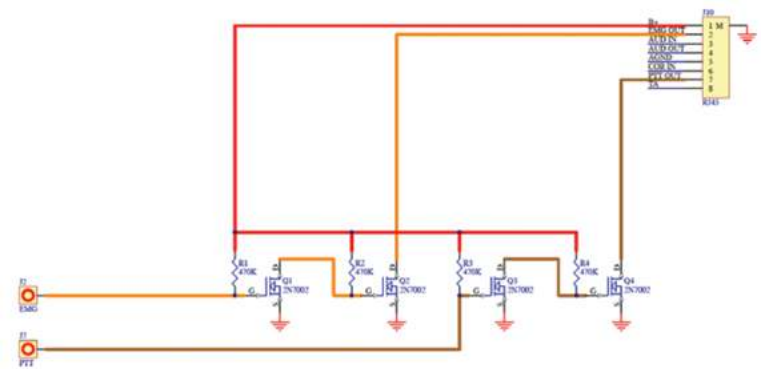

XCA-GEN Interface Adaptor:

Connects X10DR XIC cables to generic: unterminated

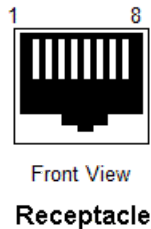
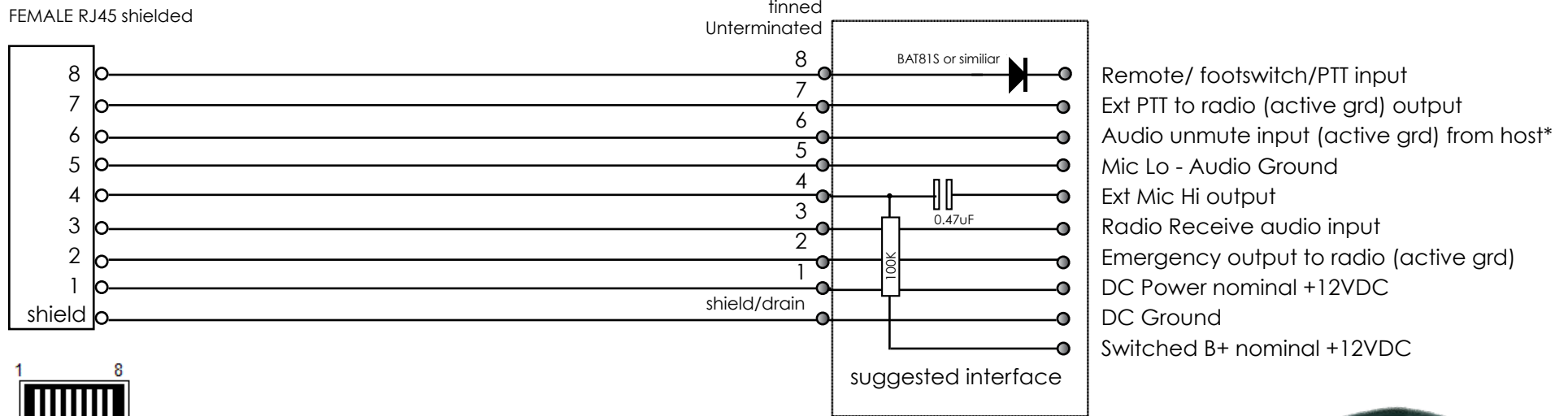

NOTES:

- 1/ Connect 100K resistor between pins 4 and radio switched B+ output so X10DR turns on when 12VDC is applied. Other wise connect to PIn one so is always on. Gateway can be manually turne off
 - 2/ Note: If host radio Mic Hi has DC voltage only when radio is powered on (Electret Mic Bias) 100K and 0.47uF cap not required.
 - 3/ If remote PTT is used then active ground switch should be via a series diode to protect Gateway input circuitry
- * if Audio unmute indicate is not available from host device leave pin unconnected (X10DR will detect receive audio to enable handset speaker.



XCA-U25M DB25 Male

Unterminated Interface Adaptor:



Female RJ45 shielded

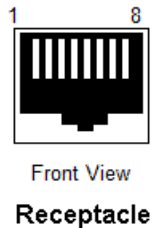

Always check the radio service manual and radio programming guide details to ensure the right connections are provided on the designated pins of the radios interface connector*.
 Note: some radios require standard jumpers to be fitted to allow External Mic Audio to be enabled. For auto off/on some radios require a 100K resistor to be fitted between SwB+ and the Mic Mic Hi output (pin 4) * also refer X10DR manual page.

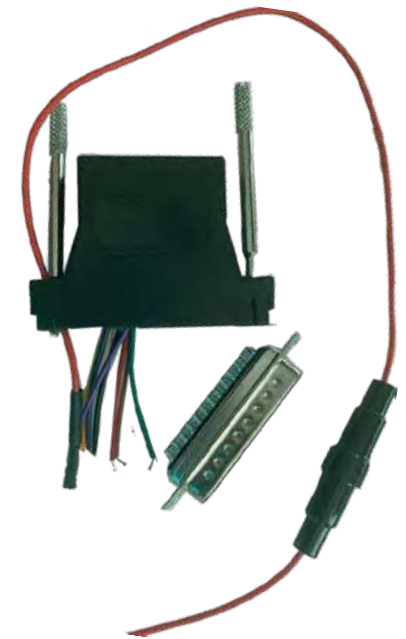
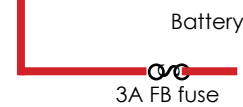
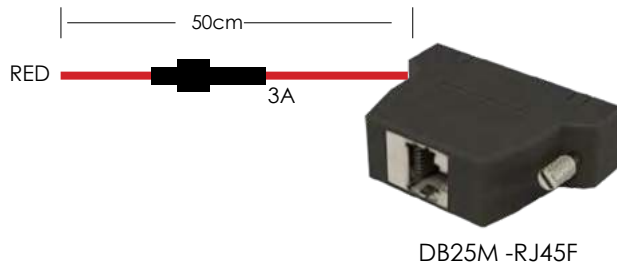

XCA-U15M DB15 Male

Unterminated Interface Adaptor:



Female RJ45 shielded

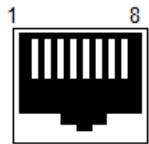

Front View

Receptacle

Always check the radio service manual and radio programming guide details to ensure the right connections are provided on the designated pins of the radios interface connector*. Note: some radios require standard jumpers to be fitted to allow External Mic Audio to be enabled. For auto off/on some radios require a 100K resistor to be fitted between SwB+ and the Mic Mic Hi output (pin 4) * also refer X10DR manual page.

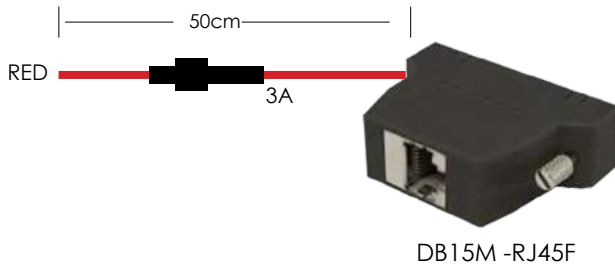

Battery

3A FB fuse

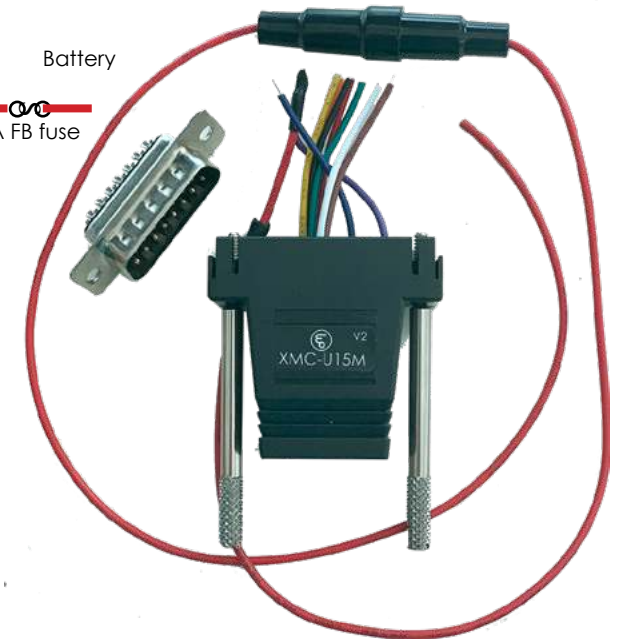

XIC-0.5 Interface cable 50cm:
XIC-1.5 Interface cable 150cm:
XIC-6.2 Interface cable 620cm:



RJ45 shielded male

RJ45 shielded male

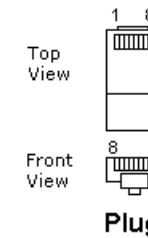
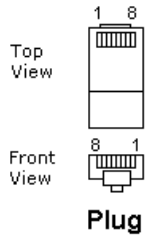
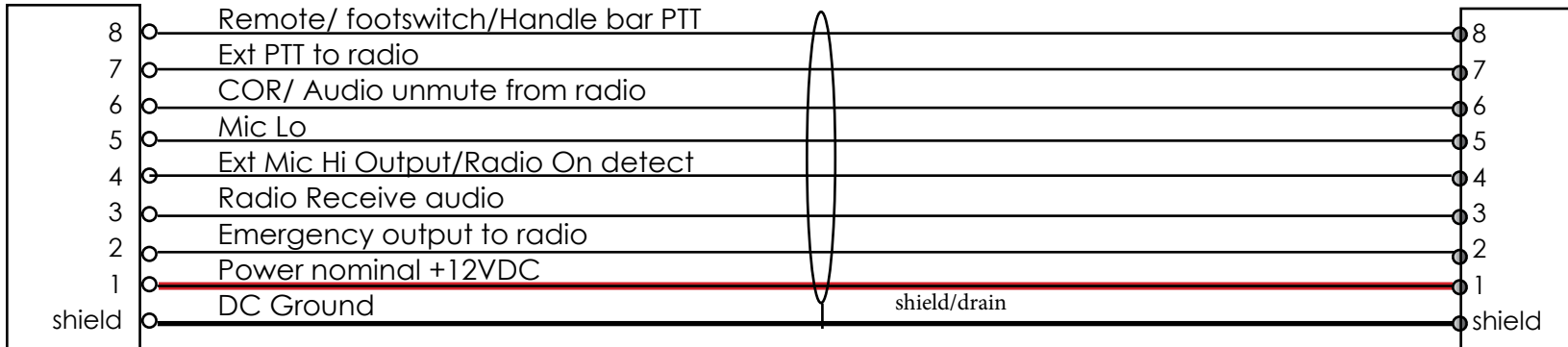

50-620 cm

26#4P+AB OD:6.0MM

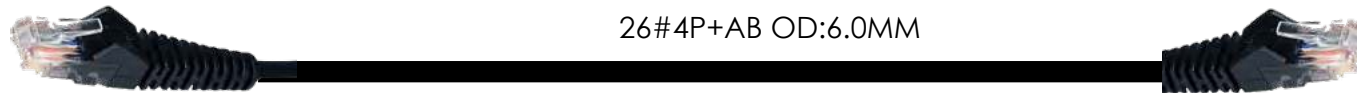

RJ45 shielded male

RJ45 shielded male



XEC-4.5 Extension cable 450cm:



RJ45 shielded female

RJ45 shielded male

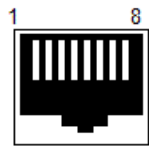
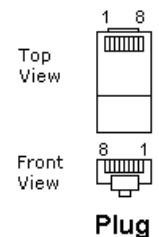
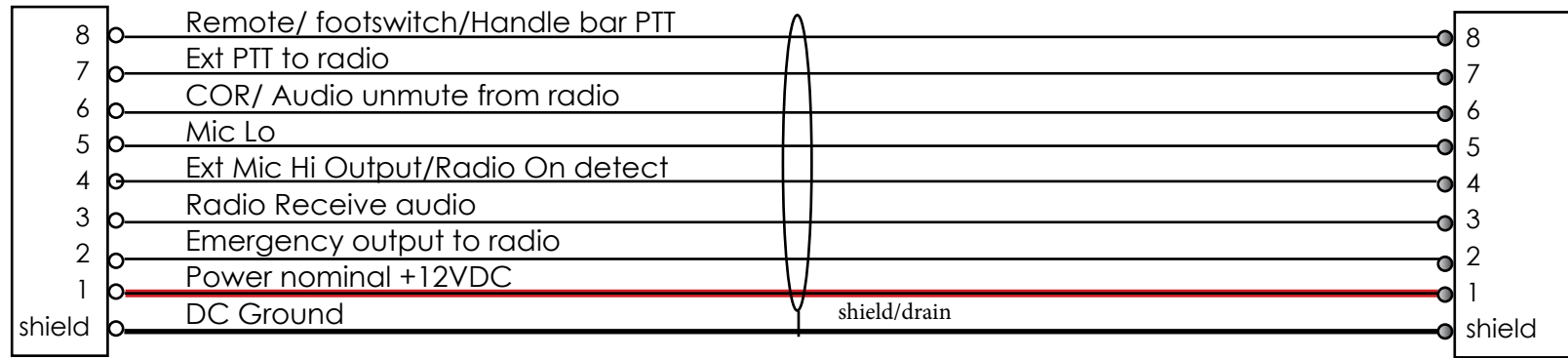

Front View

Receptacle

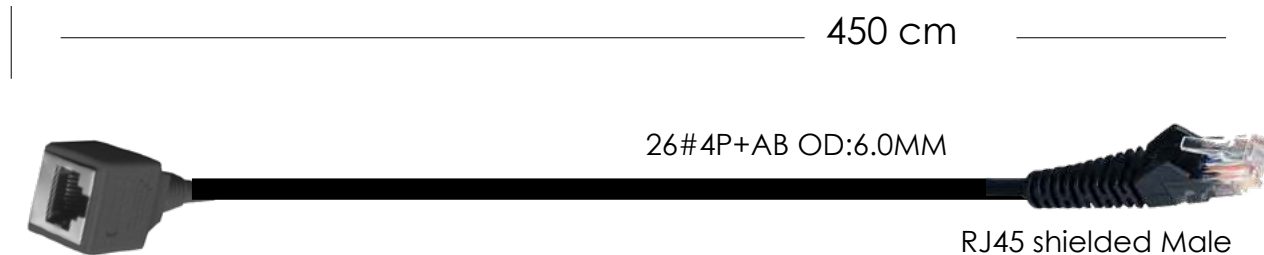

RJ45 shielded Female





All rights reserved Wireless Corporation Limited © 2020
Wireless Pacific, X10DR and their logos are trademarks or registered
trademarks of Wireless Corporation Limited. 2020 Rev 3.6